

USER MANUAL

SOFAR 15...30KTLX-G3P



CONTENTS

Preface.....	1
1 Basic Safety Information.....	3
1.1 Requirement for Installation and Maintenance.....	3
1.2 Symbols and Signs.....	6
2 Product Characteristics.....	8
2.1 Intended Use.....	8
2.2 Function Description.....	9
2.3 Electrical Block Diagram.....	10
2.4 Efficiency curve.....	11
3 Inverter Storage.....	12
4 Installation.....	13
4.1 Installation Process.....	13
4.2 Checking Before Installation.....	13
4.3 Tools.....	15
4.4 Determining the Installation Position.....	17
4.5 Moving of Inverter.....	19
4.6 Installation.....	20
5 Electrical Connection.....	22
5.1 Electrical Connection.....	23
5.2 Terminal Connector.....	23
5.3 Grounding Connection (PE).....	24
5.4 Connect Grid Side of Inverter (AC-Output).....	25
5.5 Connect PV Side Of Inverter(DC-Input).....	28
5.6 Communication Connection.....	30
5.7 Feed-in limitation connecting line.....	36
6 Commissioning of Inverter.....	37

6.1 Cable Connection Inspection	37
6.2 Start Inverter	37
7 SOFAR monitor APP	38
7.1 Software Downloads	38
7.2 Account registration and login.....	38
7.3 Local Monitoring.....	39
7.4 APP operation manual	41
8 Operation Interface	42
8.1 Operation and Display Panel	42
8.2 Standard Interface.....	42
8.3 Main Interface.....	44
8.4 Updating Inverter Software.....	51
9 Trouble Shooting and Maintenance	52
9.1 Troubleshooting	52
10 Maintenance	58
10.1 Replacing a Fan	58
11 Technical Data	60
11.1 Parameter Table.....	60

Preface

Notice

The products, services or features you purchased shall be subject to the company's commercial contracts and terms. All or part of the products and services described in this document may not within the scope of your purchase. Unless additional terms and conditions in your contract, the company does not make any statement or guarantee on the contents of this document.

Save this Instruction

This manual must be considered as an integral part of the equipment. Customer can print the electronic version to hard copy and keeping properly for future reference. Anyone who operates the device at any time must operate in accordance with the requirements of this manual.

Copyright Declaration

The copyright of this manual belongs to Shenzhen SOFARSOLAR Co., Ltd. Any corporation or individual should not plagiarize, partially cope or fully copy (including software, etc.), not allow to duplication and publication in any form and any way. All rights reserved, SOFARSOLAR reserves the right of final interpretation. This manual subject to modify according to user's or customer's feedback. Please check our website at www.sofarsolar.com for lasted version.

Document Updates

V1.0 20231102

Revised version

Outline

This manual is an integral part of SOFAR 15-30KTLX-G3P. It describes the assembly, installation, commissioning, maintenance and failure of the product. Please read it carefully before operating.

Scope of Validity

This manual contains important instructions for:





SOFAR 15KTLX-G3P SOFAR 17KTLX-G3P SOFAR 20KTLX-G3P SOFAR 20KTLX2-G3P
SOFAR 23KTLX-G3P SOFAR 25KTLX-G3P SOFAR 30KTLX-G3P

Target Group

This manual is for qualified electricians. The tasks described in this manual only can be performed by qualified electricians.

Symbols Used

The following types of safety instruction and general information appear in this document as described below:

	 Danger	“Danger” indicates a hazardous situation which, if not avoided, will result in death or serious injury.
	 Warning	“Warning” indicates a hazardous situation which, if not avoided, could result in death or serious injury
	 Caution	“Caution” indicates a hazardous situation which, if not avoided, could result in minor or moderate injury
	 Attention	“Attention” indicates there are potential risks, if fail to prevent, may lead to equipment cannot normally or property damage
	 Note	“Note” provides additional information and tips that are valuable for the optimal operation of the product

1 Basic Safety Information

Outlines of this Chapter

Please read the instruction carefully. Faulty operation may cause serious injury or death.



Note

If you have any question or problem when you read the following information, please contact Shenzhen SOFARSOLAR CO., Ltd.

Safety Instruction

Introduce the safety instruction during installation and operation of SOFAR 15-30KTLX-G3P.

Symbols Instruction

This section gives an explanation of all the symbols shown on the inverter and on the type label.

1.1 Requirement for Installation and Maintenance

- Installation of SOFAR 15-30KTLX-G3P on-grid inverter must conform with laws, regulations, codes and standards applicable in the jurisdiction.
- Before installing and adjusting the produce, please read all of instructions, cautions and warnings in this manual.
- Before connecting the product to the electrical utility grid, contact the local utility company for allowance. Also, this connection must be made only by a qualified electrician.
- If the failure persists, please contact the nearest authorized maintenance center. If you don't know which service center is closest to you, please contact your local distributor. Don't repair the product by yourself, which may lead serious injury or damage.

Qualified Person

When inverter is working, it contains lethal voltages and went hot in some area. Improper installation or misoperation could cause serial damage and injury. To reduce the risk of personal injury and to ensure the safe installation and operation of the product, only a qualified electrician is allowed to execute transportation, installation, commissioning and maintenance. Shenzhen SOFARSOLAR Co, Ltd. does not take any responsibility for the property destruction and personal injury because of any incorrect use.

Label and Symbols

SOFAR 15-30KTLX-G3P has type label attach the side of product which contact important information and technical data, the type label must permanent attached to the product.

SOFAR 15-30KTLX-G3P has warning symbol attached the product which contact information of safety operation. The warning symbol must permanent attached to the product.

Installation location requirement

Please install the inverter according to the following section. Place inverter in an appropriate bearing capacity objects (such as solid brick wall, or strength equivalent mounting surface, etc.) and make sure inverter vertical

placed. A proper installation location must have enough space for fire engine access in order for maintenance if faulty occur. Ensure the inverter is installed in a wall ventilated environment and have enough air cooling cycle. Air humidity should less than 90%.

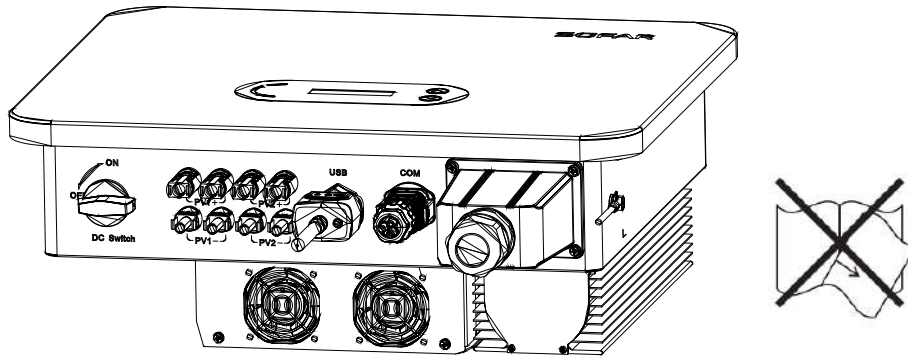



Transportation Requirement

Inverter is in the good electrical and physical condition when it ship out from factory. During transport, inverter must be placed in its original package or other proper package. Transportation company should responsible for any damage during transport period.



If you find any packing problems that may cause the damage of inverter or any visible damage, please notice the responsible transportation company immediately. You can ask your installer or SOFARSOLAR for help is necessary.

Electrical Connection



Please comply with all the current electrical regulations about accident prevention in dealing with the current inverter.

	 Danger	Before the electrical connection, use opaque material to cover the PV modules or disconnect PV string DC switch. PV arrays will produce dangerous voltage if it is exposure under sun.
	 Warning	All operation must accomplish by certified electrical engineer. <ul style="list-style-type: none"> •Must be trained. •Completely read the manual operation and understand all information.
	 Attention	Must get permission by local utility company before connecting to grid and the connection must be done by certified electrical engineers.

Operation

	 Danger	Touching the utility grid or the terminal conductors can lead to lethal electric shock or fire! Do not touch non-insulated cable ends, DC conductors and any live components of the inverter. Attention to any electrical relevant instruction and document.
	 Attention	Enclosure or internal components may get hot during operation. Do not touch hot surface or wear insulated gloves. Keep it away from kids!

Maintenance and repair

	 Danger	<p>Before any repair work, turn OFF the AC circuit breaker between the inverter and electrical grid first, then turn OFF the DC switch.</p> <p>After turning OFF the AC circuit breaker and DC switch wait for at least 5 minutes before carry any maintenance or repair work.</p>
	 Attention	<p>Inverter should not work again until removing all faults. If any repair work is required, please contact local authorized service center.</p> <p>Should not open the inverter cover without authorized permit, SOFARSOALR does not take any responsibility for that.</p>





EMC/Noise Level

Electromagnetic compatibility (EMC) refers to that on electrical equipment functions in a given electromagnetic environment without any trouble or error, and impose no unacceptable effect upon the environment. Therefore, EMC represents the quality characters of an electrical equipment.

- The inherent noise-immune character: immunity to internal electrical noise
- External noise immunity: immunity to electromagnetic noise of external system
- Noise emission level: influence of electromagnetic emission upon environment









	 Danger	<p>Electromagnetic radiation from inverter may be harmful to health!</p> <p>Please do not continue to stay away from the inverter in less than 20cm when inverter is working</p>
--	--	--

1.2 Symbols and Signs

	 Danger	<p>High voltage of inverter may be harmful to health!</p> <p>Only certified engineer can operate the product;</p> <p>Juveniles, Disable, should not use this product;</p> <p>Keep this product out of the reach of children;</p>
	 Caution	<p>Caution of burn injuries due to hot enclosure!</p> <p>Only touch the screen and pressing key of the inverter while it is working</p>
	 Attention	<p>PV array should be grounded in accordance to the requirements of the local electrical grid company</p>
	 Warning	<p>Ensure the maximum DC voltage input is less than the maximum inverter DC voltage (including in low temperature condition). Any damage cause by overvoltage, SOFARSOLAR will not take the responsibility including warranty</p>

Signs on the Product and on the Type Label

SOFAR 15-30KTLX-G3P has some safety symbols on the inverter. Please read and fully understand the content of the symbols before installation.

Symbols	Name	Explanation
	This is a residual voltage in the inverter	After disconnect with the DC side, there is a residual voltage in the inverter, operator should wait for 5 minutes to ensure the capacitor is completely discharged.
	Caution of high voltage and electric shock	The products operates at high voltages. Prior to performing any work on the product, disconnect the product from voltage sources. All work on the product must be carried out by qualified persons only.
	Caution of hot surface	The product can get hot during operation. Avoid contact during operation. Prior to performing any work on the product, allow the product to cool down sufficiently
	Comply with the Conformite Europeenne (CE) Certification	The product comply with the CE Certification
	Grounding Terminal	This symbol indicates the position for the connections of an additional equipment grounding conductor
	Observe the documentation	Read all documentation supplied with the product before install
	Positive pole and negative pole	Positive pole and negative pole of the input voltage (DC)
	Temperature	Indicated the temperature allowance range
	RCM logo	RCM (Regulatory Compliance Mark) The product complies with the requirements of the applicable Australian standards.

2 Product Characteristics

Outlines of this Chapter

Product Dimensions

Introduce the field of use and the dimensions of the product

Function Description

Introduce working principle and internal components

Electrical block diagram

Introduce the electrical block diagram of the product

2.1 Intended Use

SOFAR 15-30KTLX-G3P is a transformerless on grid PV inverter, that converts the direct current of the PV array to the grid-compliant, three-phase current and feeds into the utility grid.

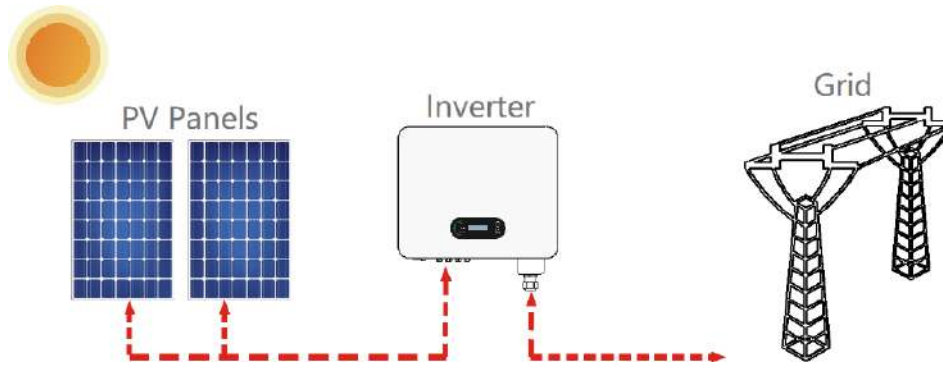
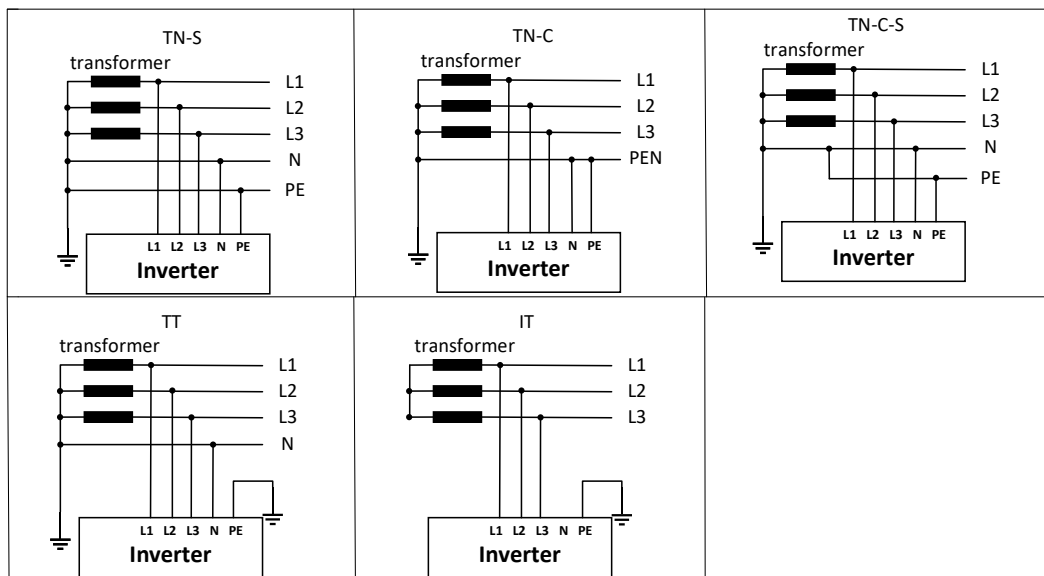

Figure 2-1 PV Grid-Tied System

SOFAR 15-30KTLX-G3P may only be operated with PV arrays (photovoltaic module and cabling) for on grid condition. Do not use this product for any other or additional purposes. Any damage or property loss due to any use of the product other than described in this section, SOFARSOLAR will not take the responsibility. DC input of the product must be PV module, other source such like DC sources, batteries will against the warranty condition and SOFARSOLAR will not take the responsibility.

Supported grid types



Product Dimensions

The choice of optional parts of inverter should be made by a qualified technician who knows the installation conditions clearly.

Dimensions Description

•SOFAR 15-30KTLX-G3P

L×W×H=491*412*188mm

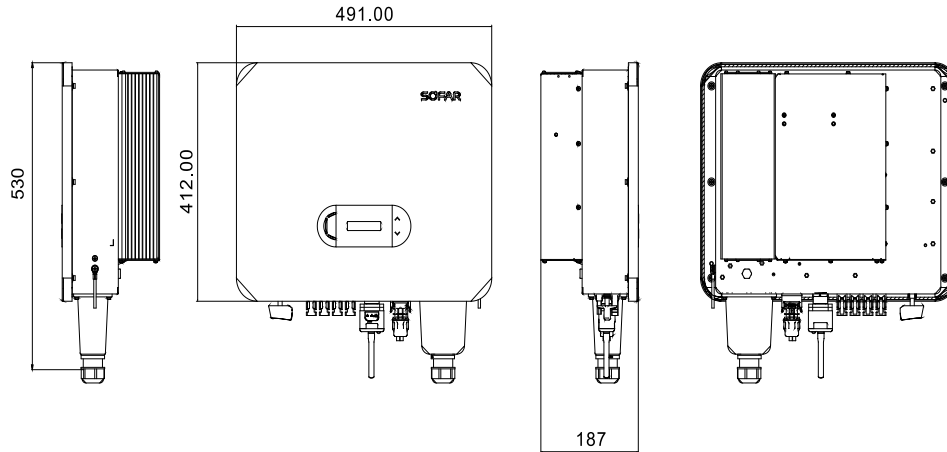

Figure 2-2 Product front view and left view dimensions

Labels on the equipment

Note: label must NOT be hidden with objects and extraneous parts (rags, boxes, equipment, etc.); they must be cleaned regularly and kept visible at all times.

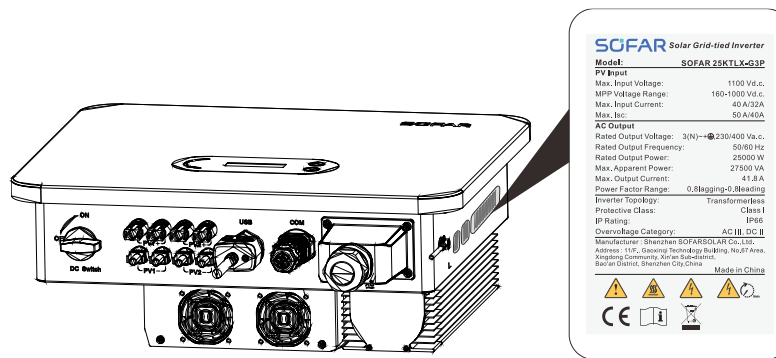

Figure 2-3 Product label

2.2 Function Description

DC power generated by PV arrays is filtered through Input Board then enter Power Board. Input Board also offer functions such as insulation impedance detection and input DC voltage/ current detection. DC power is converted to AC power by Power Board. AC power is filtered through Output Board then AC power is fed into the grid. Output Board also offer functions such as grid voltage/ output current detection, GFCI and output isolation relay. Control Board provides the auxiliary power, controls the operation state of inverter and shows the operation status by Display Board. Display Board displays fault code when inverter is abnormal operation conditions. At the same time, Control Board can trigger the replay to protect the internal components.

Function Module

A. Energy management unit

Remote control to start/ shunt down inverter through an external control.

B. Feeding reactive power into the grid

The inverter is able to produce reactive power thus to feed it into the grid through the setting of the phase shift factor. Feed-in management can be controlled directly by the grid company through a RS485 interface.

C. Limited the active power fed into grid

If enable the limited of active power function, inverter can limit the amount of active power fed into the grid to the desired value (expressed as percentage).

D. Self-power reduction when grid is over frequency

If grid frequency is higher than the limited value, inverter will reduce the output power to ensure the grid stability.

E. Data transmission

Inverter or a group of inverters can be monitored remotely through an advanced communication system based on RS485 interface or via WiFi/Ethernet.

F. Software update

USB interface for uploading the firmware, remotely uploading is available.

G. PID recovery

The PID effect can be recovered at night to protect the PV modules.

2.3 Electrical Block Diagram

SOFAR 15-30KTLX-G3P has 20 DC input strings. 10 MPPT trackers that converts the direct current of PV array to grid-compliant, three phase current and feeds in into the utility grid. Both DC and AC side has Surge Protection Device (SPD).

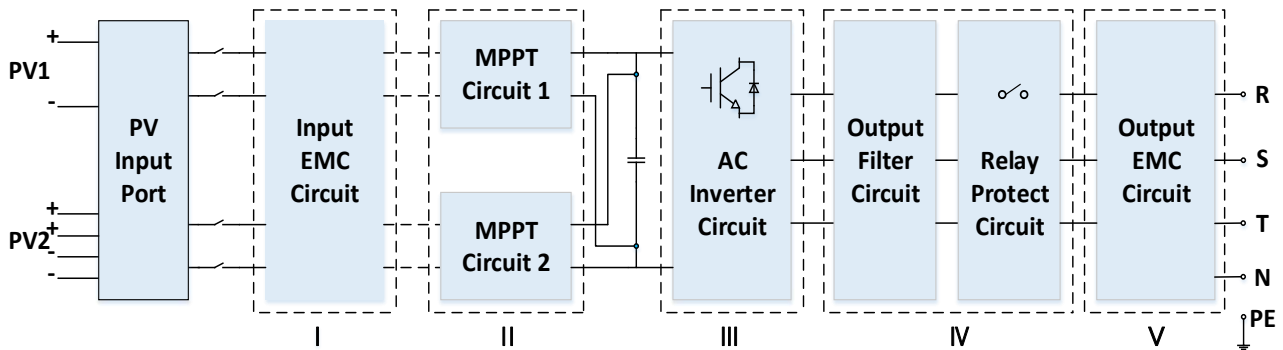
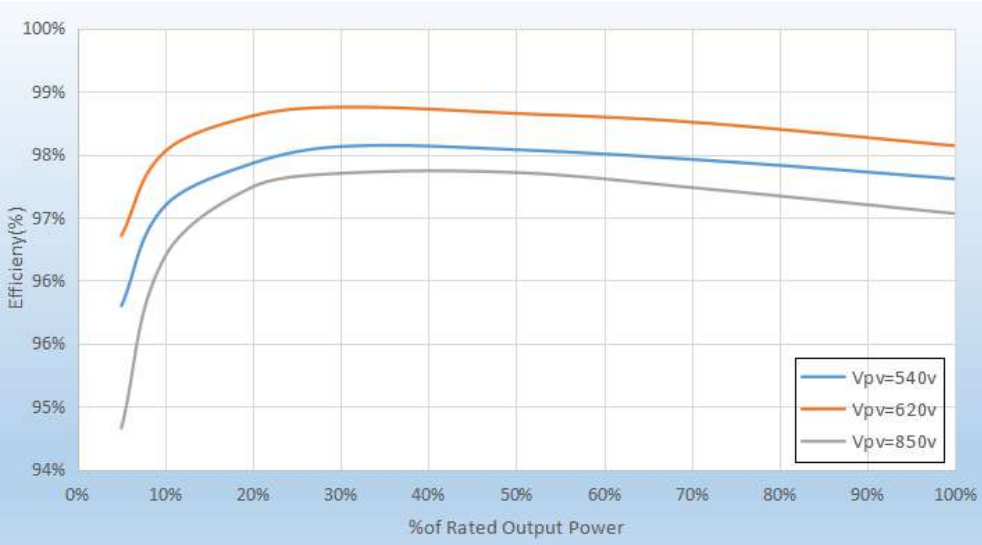

Figure 2-4 Electrical block diagram

2.4 Efficiency curve



3 Inverter Storage

If inverter is not installing immediately, storage condition need meet below requirements:

- Place inverter into the original package and leave desiccant inside, sealed tight with taps.
- Keep the storage temperature around $-40^{\circ}\text{C}\sim 70^{\circ}\text{C}$, Relative humidity 5~95%, no condensation

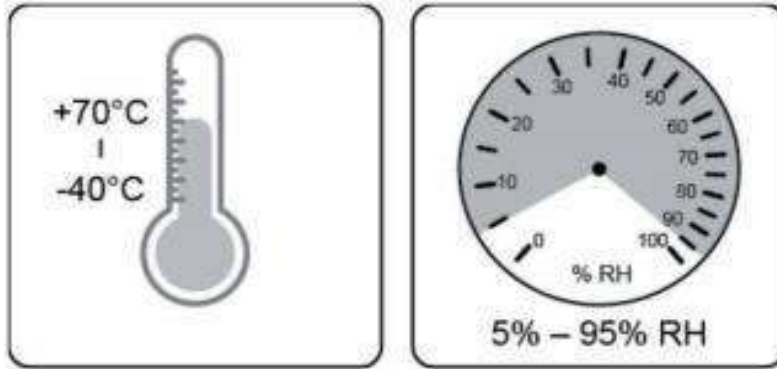





Figure 3-1 Storage temperature and humidity

- The maximum stacking layer number cannot exceed 4 layers.
- If the inverter be storage for more than half years, the inverter needs to be fully examined and tested by qualified service or technical personnel before using.

4 Installation

Outlines of this Chapter

This topic describes how to install this product, please read carefully before install.

	 Danger	Do not install the product on flammable material. Do not store this product in potentially explosive atmospheres.
	 Caution	The enclosure and heat sink will get hot during operation, please do not mount the product at a easy to reach location.
	 Attention	Consider the weight of this product when doing transport and moving. Choose an appropriate mounting position and surface. At least two persons for installation.

4.1 Installation Process



4.2 Checking Before Installation









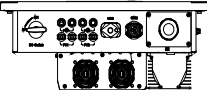
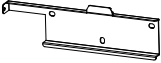

Checking Outer Packing Materials

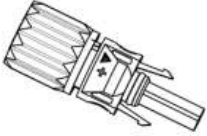

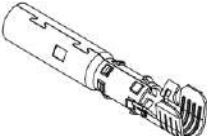
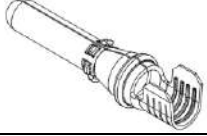
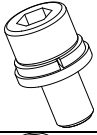
Before unpacking, please check the condition of the outer package materials if any damaged found, such as holes, cracks, please not unpack the product, contact your distributor immediately. Recommend installing the product within 24 hours after unpacking the package.

Checking Deliverable

After unpacking, please check according to following table, to see whether all the parts were included in the packing, please contact your distributor immediately if anything missing or damage.

Table 4-1 Components and mechanical parts that inside the package



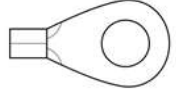
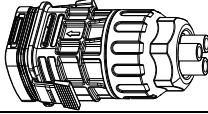
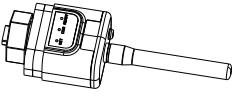

No	Pictures	Description	Quantity
1		SOFAR 15-30KTLX-G3P	1pcs
2		Rear Panel	1pcs
3		M8*80 expansion bolt	3pcs
4		PV+ input connector	3pcs (15kW/17kW/20kW) 4pcs (20Kw/23kW/25kW/30kW)
5		PV- input connector	3pcs (15kW/17kW/20kW) 4pcs (20Kw/23kW/25kW/30kW)
6		PV+ metal pin	3pcs (15kW/17kW/20kW) 4pcs (20Kw/23kW/25kW/30kW)
7		PV- metal pin	3pcs (15kW/17kW/20kW) 4pcs (20Kw/23kW/25kW/30kW)
8		M6 Hexagon screws	1pcs
9		M5 Cross set screw	1pcs
10		M4 Cross set screw	4pcs
11		AC waterproof cover	1pcs
12		Manual	1pcs
13		Warranty Card	1pcs





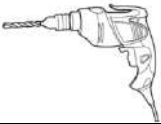

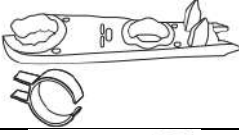
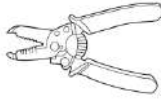
14		Product Certification	1pcs
16		Quality Certificate	1pcs
17		R 型端子	5pcs
18		COM connector	1pcs
19		USB WiFi Stick Logger	1pcs

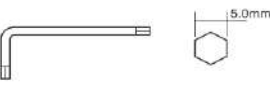
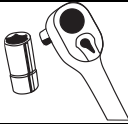
4.3 Tools

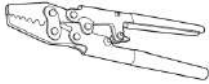
Prepare tools required for installation and electrical connection as following table:

Table 4-2 Installation tools

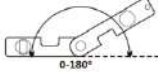
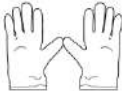
No	Tool	Description	Function
1		Hammer Drill Recommend drill @ 10mm	Used to drill holes on the wall
2		Screwdriver	Use to tighten and loosen screws when installing AC power cable Use to remove AC connectors from the product
3		Removal Tool	Remove PV Connector
4		Wire Stripper	Used to peel cable
5		Rubber Mallet	Used to hammer expansion bolts into holes
6		M6	M6 use to uninstall and install the front top cover and down cover
7		Socket Wrench	Fasten the cable and Install the expansion bolt

8		Crimping Tool	Use to crimp cable on grid side, load side and CT extensive cable
9		Multimeter	Check grounding cable, PV positive and negative pole
10		Marker	Mark signs
11		Measuring Tape	Measure distance
12		Level	Ensure the rear panel is properly installed
13		ESD gloves	Installer wear when installing product
14		Safety goggles	Installer wear when installing product
15		Mask	Installer wear when installing product

4.4 Determining the Installation Position

Select a appropriate location to install the product to make sure the inverter can work in a high efficiency condition.

When selecting a location for the inverter, consider the following:

Note: Install vertical or backward tilt within 0-75°, Do not install forward or upside down!

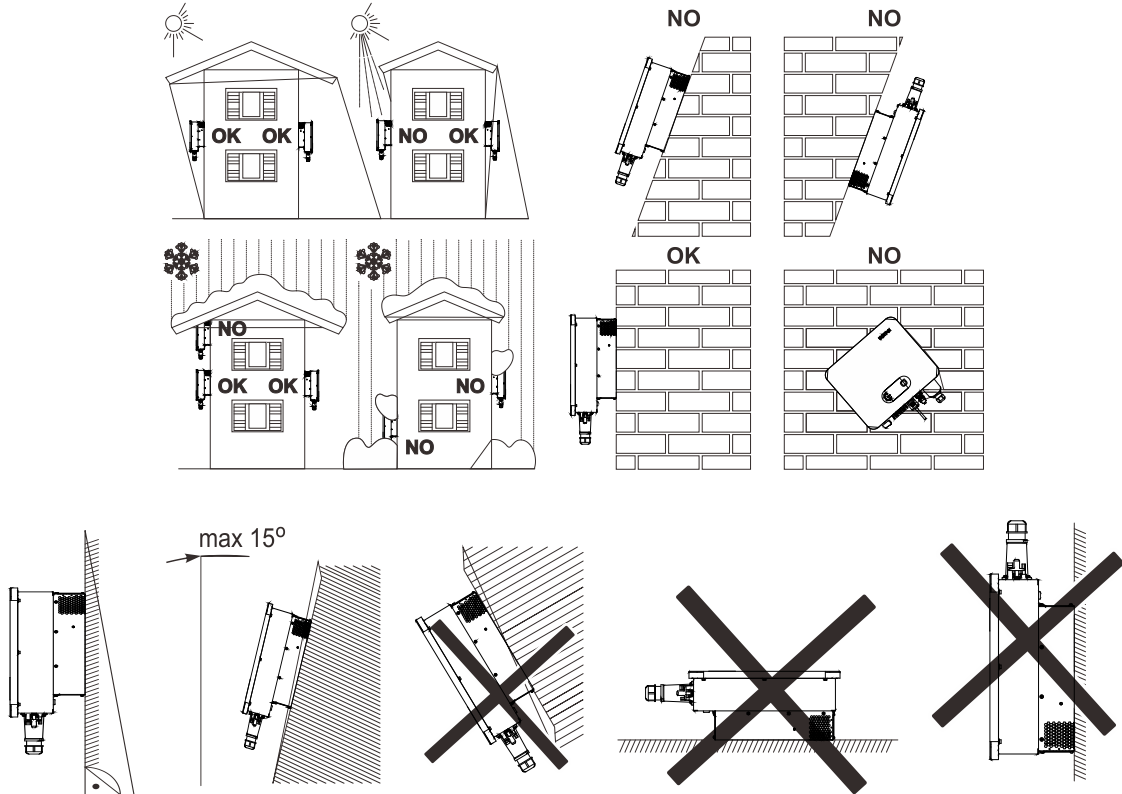

Figure 4-1 Installation Position Selection

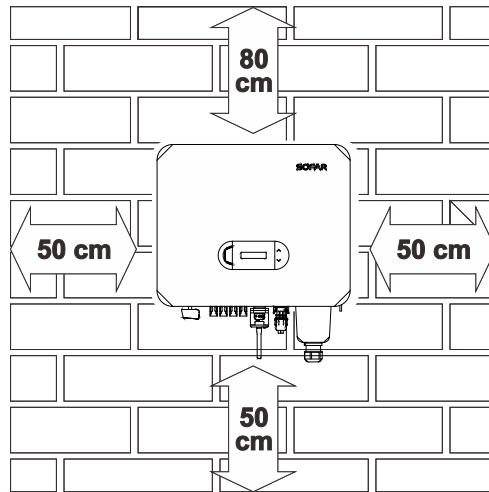

Figure 4-2 Clearance for single inverter

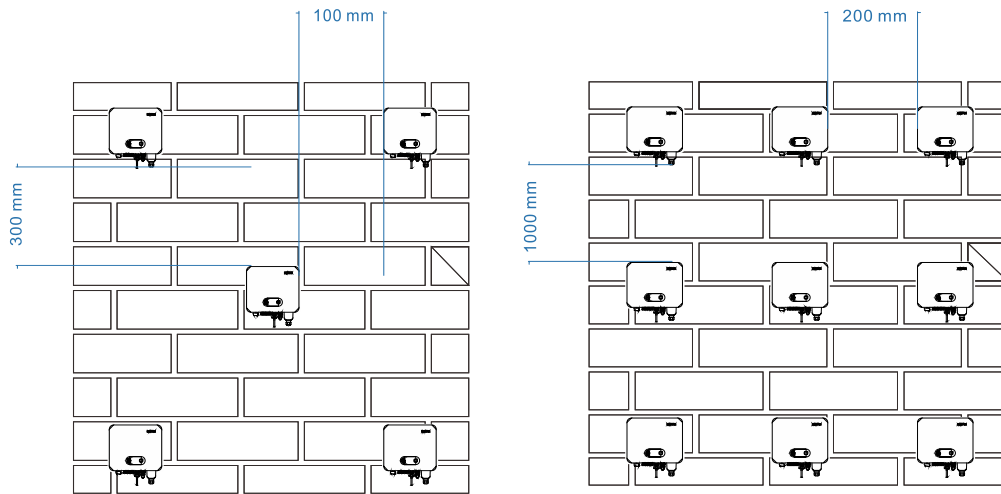

Figure 4-3 Clearance for multiple inverters

Note:

Other requirement for install position:

- Install position should obstruct the disconnect of power
- Place inverter in an appropriate bearing capacity objects
- Location should be avoid touch by children

4.5 Moving of Inverter

Manual handling

Unload the inverter from package, horizontally move to the install position. When open the package, at least two operator insert the hands into the slots on both side of the inverter and hold the handles.

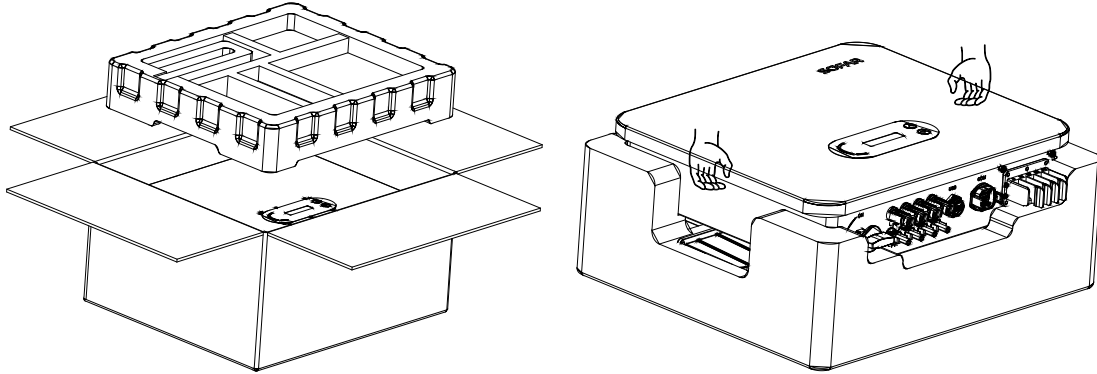

Figure 4-4 Move inverter from package



Attention

Keep the balance when lift the inverter. Required at least two operators for lifting or use forklift. Inverter is heavy, dropped while being transported may cause injuries.

Do not put the inverter with wiring terminals contacting the floor because the power ports and signal ports are not designed to support the weight of the inverter.

When place inverter on the floor, put it above foam or paper to avoid the damage of the shell of inverter.

4.6 Installation

4.6.1 Installed on wall

Step 1: Placed the rear panel on the mounting wall, determine the mounting height of the bracket and mark the mounting poles accordingly. Drilling holes by using Hammer Drill, keep the hammer drill perpendicular to the wall and make sure the position of the holes should be suitable for the expansion bolts.

Step 2: Insert the expansion bolt vertically into the hole;

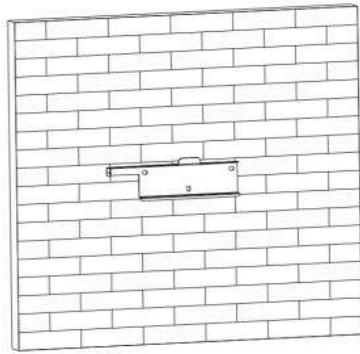

Step1

Figure 4-5 Drilling holes on the mounting wall

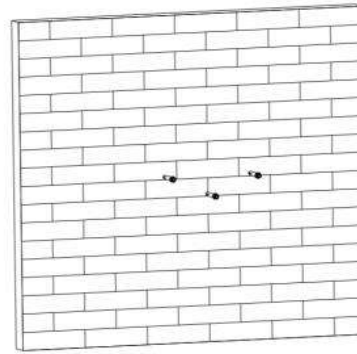

Step2

Figure 4-6 Screws into the holes

Step 3: Align the rear panel with the hole positions, fix the rear panels on the wall by tightening the expansion bolt with the nuts.

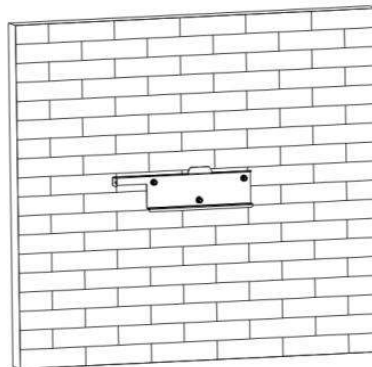

Step3

Figure 4-7 Install rear panel

Step 4: Lift the inverter and hang it on the rear panel, and fixing both side of inverter with M6 screw (accessories).

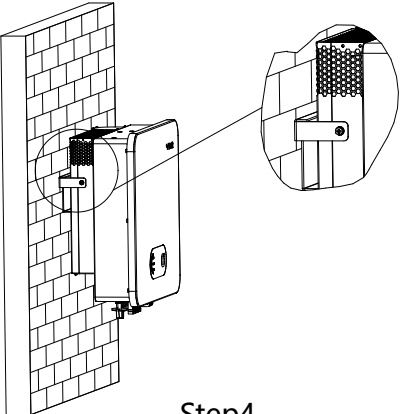

Step4

Figure 4-8 Fix inverter



5 Electrical Connection

Outlines of this Chapter

This section introduces the electrical connection for the product. Please read the information carefully, it may helpful to understand the grounding wiring, DC input connection, AC output connection and communication connection.

Caution:

Before performing electrical connections, ensure the DC switch is OFF and AC circuit breaker is OFF. Waiting 5 minutes for the capacitor to be electrically discharged.

 Attention	Installation and maintenance should be done by certified electrical engineer
 Danger	Before the electrical connection, use opaque material to cover the PV modules or disconnect PV string DC switch. PV arrays will produce dangerous voltage if it is exposure under sun
 Note	For this product, the open circuit voltage of PV strings should not greater 1100V

● Electrical Connection

Introduce the electrical connection process.

● Terminal Port

Introduce inverter terminal port layout.

● Grounding Protection (PE)

Connect PE line for grounding protection.

● Connect AC output (AC-Output)

Connect AC output for feeding generated electrical into the utility grid. Must meet the requirement of local utility grid company.

● DC input connection

Connect PV array with inverter by DC cable.

● Wiring method recommended

Introduces the recommended wiring methods for different strings.

● Communication Connection

Introduce the propose USB/WIFI, COM and how to connect USB/WIFI port.

● Safety check

Before operate inverter, check the PV array, inverter DC side safety connection and AC side safety connection.

5.1 Electrical Connection

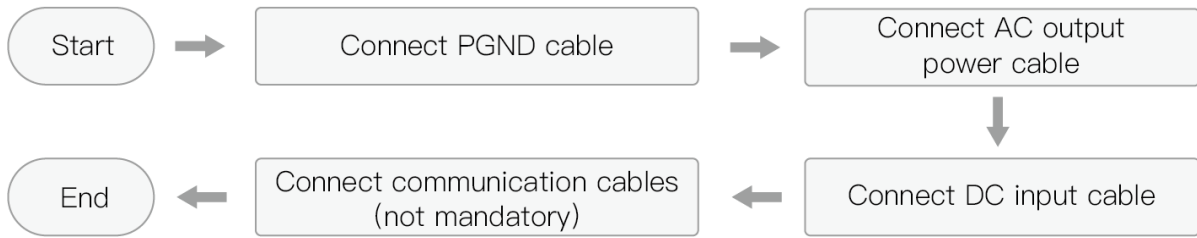

5.2 Terminal Connector

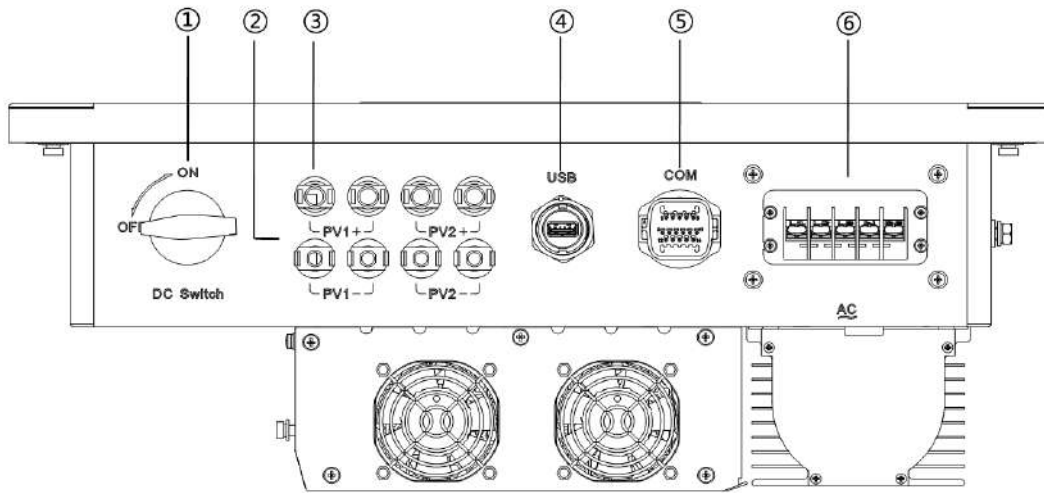



Figure 5-1 Introduction to terminal blocks

*Take picture as reference

No	Name	No	Name
①	DC Switch	②	PV- Connector
③	PV+ Connector	④	USB Connector
⑤	Com Connector	⑥	AC Connector

5.3 Grounding Connection (PE)

Connect the inverter to the grounding electrode using ground cable.

	 Note	<p>SOFAR 15-30KTLX-G3P is a transformerless inverter which requires the positive pole and negative pole of the PV array are NOT grounded. Otherwise, it will cause inverter failure. In the PV system, all non-current-carrying metal parts (such as mounting frame, combiner box enclosure, etc.) should be connected to earthed.</p>
--	--	--

Preparation: prepare the grounding cable (recommend 10mm² yellow-green outdoor cable and M6 OT Terminal)

Procedure:

Step 1: Remove the insulation layer with an appropriate length using a wire stripper shown as figure 5-2.

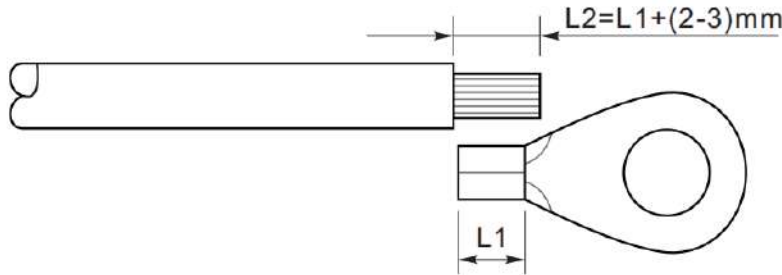

Figure 5-2 Grounding connection instruction (1)

Note: the length of L2 should 2~3mm higher than L1.

Step 2: Insert the exposed core wires into the OT terminal and crimp them by using a crimping tool, as shown as figure 5.3. Recommend using OT terminal: OT M6, Cable: ≥10mm².

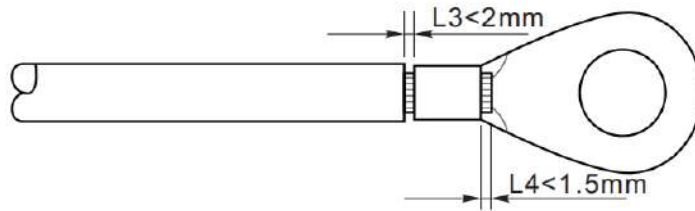

Figure 5-3 Grounding connection instruction (2)

Note 1: L3 is the length between the insulation layer of the ground cable and crimped part. L4 is the distance between the crimped part and core wires protruding from the crimped part.

Note 2: The cavity formed after crimping the conductor crimp strip shall wrap the core wires completely. The core wires shall contact the terminal closely.

Step 3: Remove the screw from the bottom side of inverter (Shown as figure 5-4), connect the grounding cable to the grounding point and tighten the grouping screw. Torque is 5N.m.

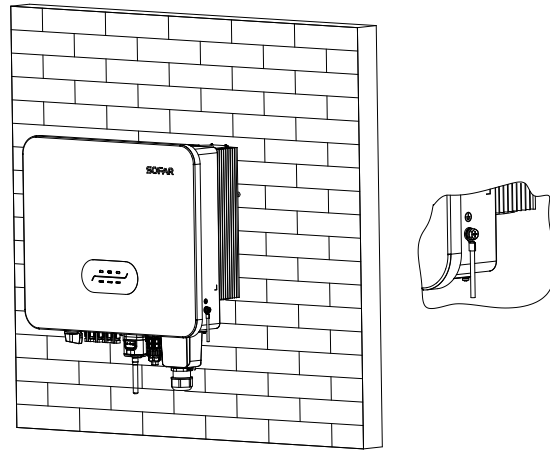

Figure 5-4 Inverter external grounding instruction diagram

Note : For improving anti-corrosion performance, after ground cable installed, apply silicone or paint is preferred to protect.

5.4 Connect Grid Side of Inverter (AC-Output)

For Belgium, one of the following links is required for external AC relay.

<https://www.synergriid.be/images/downloads/c10-21-decoupling-relays-nf.pdf>

Inverter has a standard and integrated residual current monitoring unit (RCMU), when inverter detected leakage current excess 30mA, it will cut off with utility grid for protection. For external Residual Current Device (RCD), the rated residual current shall be 30mA or higher.

Precondition:

- Inverter AC side should connect a three phase circuit current to ensure inverter can be cut off with utility grid for abnormal condition.
- The AC cable need to meet the requirement of local grid operator.

Model	Cross section area of Cu cable (mm ²)	Muti-core outdoor cable (mm)	AC Circuit Breaker specification
SOFAR 15KTLX-G3P	8~16 recommend 10	17~24	40A/230V/3P current leakage protection 0.1A
SOFAR 17KTLX-G3P	8~16 recommend 12	17~24	40A/230V/3P current leakage protection 0.1A
SOFAR 20KTLX-G3P	8~16 recommend 12	17~24	40A/230V/3P current leakage protection 0.1A
SOFAR 20KTLX2-G3P	8~16 recommend 12	17~24	40A/230V/3P current leakage protection 0.1A
SOFAR 23KTLX-G3P	8~16 recommend 14	17~24	63A/230V/3P current leakage protection 0.1A
SOFAR 25KTLX-G3P	8~16 recommend 14	17~24	63A/230V/3P current leakage protection 0.1A

SOFAR 30KTLX-G3P	8~16 recommend 14	17~24	63A/230V/3P current leakage protection 0.1A
------------------	----------------------	-------	--

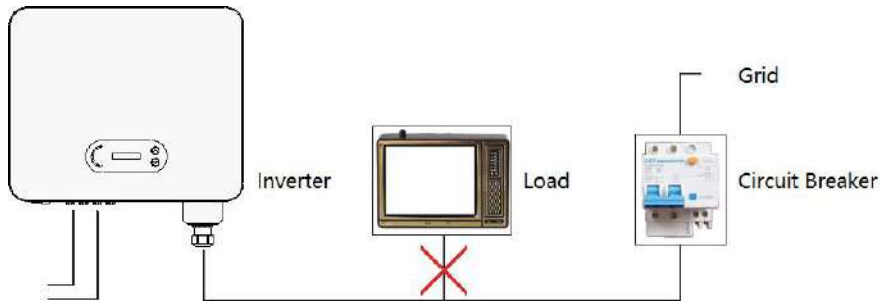

Figure 5-5 relation between cable length, cross section area and power loss

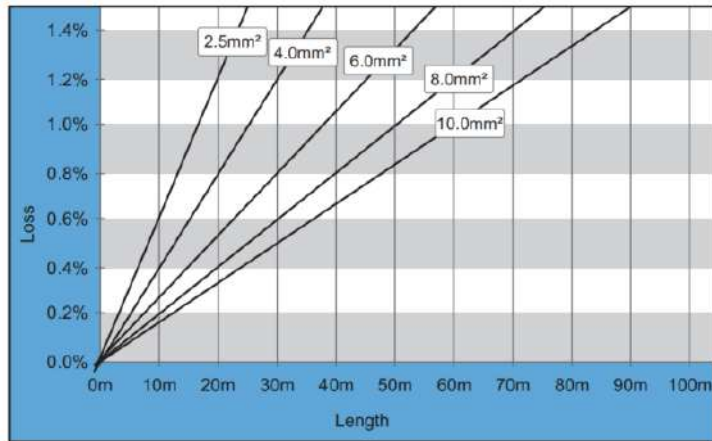

Figure 5-6 relation between cable length, cross section area and power loss

The AC output terminal of this product is equipped with high current 5-core terminal block and customized AC output waterproof cover, which can meet the IP65 level requirements after installation. AC cable need customer self connect, the out looking is as below figure 5-7:

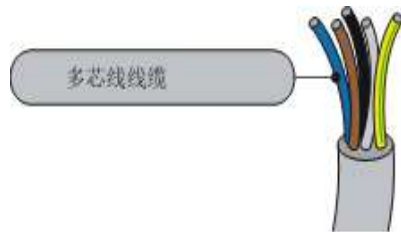
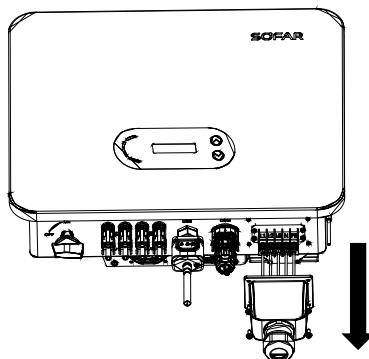

Figure 5-7 SOFAR 15-30KTLX-G3P AC terminal connector picture

Step 1: Remove the AC waterproof cover screw with a screwdriver, and take out the stopper in the PG waterproof joint.



Step 2: Select the appropriate cable diameter according to table 5-1, process the cable according to the following picture size requirements, and then pass through PG waterproof joint

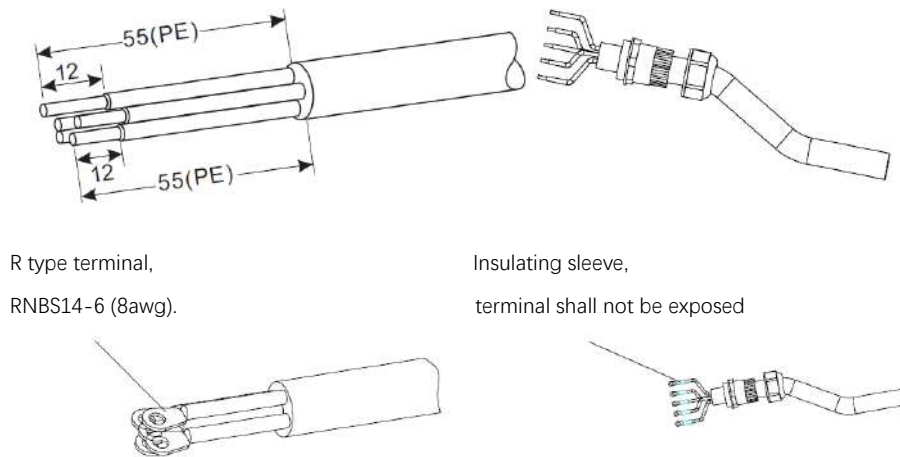

Figure 5-9 AC cable connection instruction diagram(1)

Step 3: After assembling the PG waterproof connector, connect the cable to the AC terminal block L1, L2, L3, N, PE contacts, and fasten them (4~5 N · m). Tighten the lock nut of PG terminal clockwise (7~8 N · m).

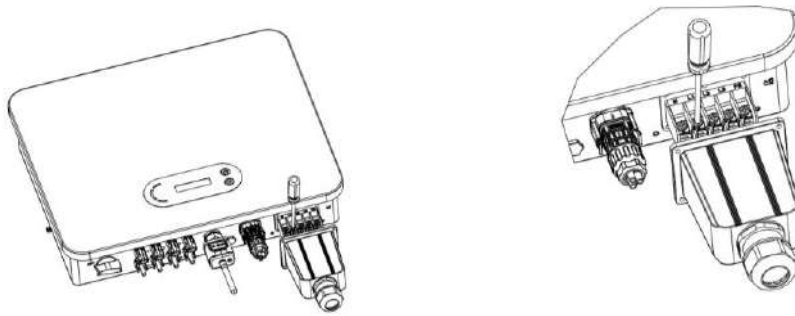

Figure 5-10 AC cable connection instruction diagram(2)

Note:

- Before connect to grid, please ensure the grid voltage and frequency of local grid meet the requirement of inverter , any question please seek local grid company for help.
- Inverter can only connect to grid after get the permission from local grid company.
- Should not connect any loads between inverter and AC circuit breaker.

OT/DT Requirement:

- When use copper core cable, please use copper terminal connector.
- When use copper clad aluminum cable, please use copper terminal connector.
- When use aluminum core cable, please use Copper and aluminum transition terminal connector or aluminum terminal connector.

5.5 Connect PV Side Of Inverter(DC-Input)

Note:

- Connecting PV strings into inverter must following the below procedure. Otherwise, any faulty cause by inappropriate operation will be including in the warranty case.
- Ensure the maximum short circuit current of PV strings should less than the maximum inverter DC current input. And three “DC switch” is in OFF position. Otherwise, it may cause high voltage and electric shock.
- Ensure PV array have good insulation condition in any time.
- Ensure same PV string should have the same structure, including: same model, same number of panels, same direction, same azimuth.
- Ensure PV positive connector connect to inverter positive pole, negative connector connect to inverter negative pole
- Please use the connectors in the accessories bag. The damage cause by incorrect is not including in the warranty.

Table 5-2 Recommend DC cable size

Copper cable cross section area(mm ²)		Cable OD(mm)
Range	Recommend	
4.0~6.0	4.0	4.5~7.8

Step 1: Find the metal contact pins in the accessories bag, connect the cable according below diagram (1.Positive cable, 2. negative cable);

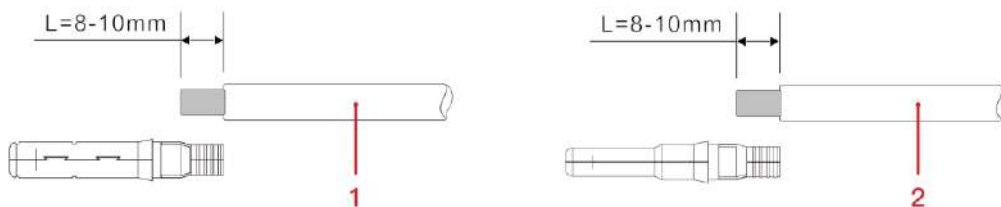
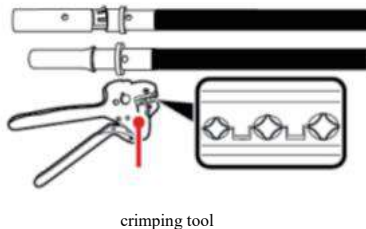
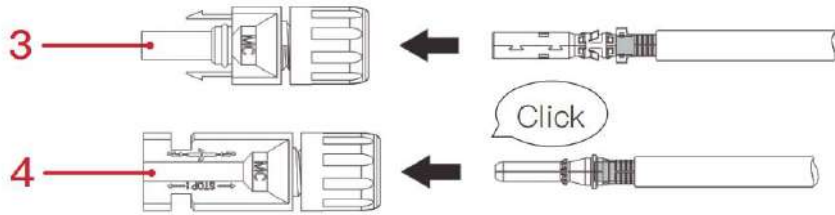

Figure 5-8 DC cable connection (1)

Step 2: Crimp the PV metal contact pin to the striped cable using a proper crimping pliers;



Step 3: Insert wire into the connector cap nut and assemble into the back of male or female plug, When you heard a “click”, the pin tact assembly is seated correctly. (3. Positive connector, 4. Negative connector);



Step 4: Measure PV voltage of DC input with multimeter, verify DC input cable polar and connect DC connector with inverter until hearing a slight sound indicated connection succeed (5. Positive cable, 6. Negative cable).

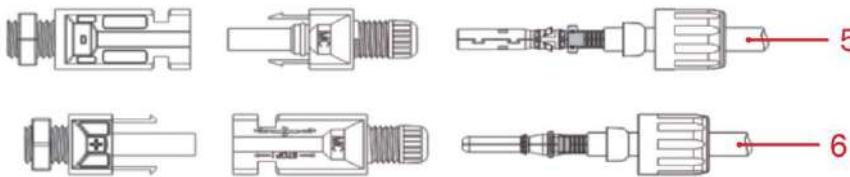
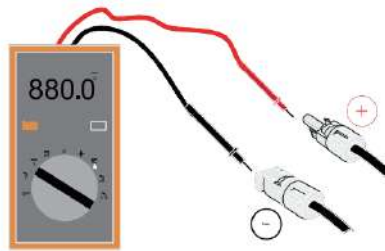



Figure 5-9 DC cable connection



Note: Please use multimeter to make sure the PV array positive pole and negative pole!

Dealing: If need to remove the PV connector from inverter side, please use the Removal Tool as below diagram, move the connector gently.

 Note	Before, moving the positive and negative connector, please make sure “DC Switch” is on OFF position.
--	--

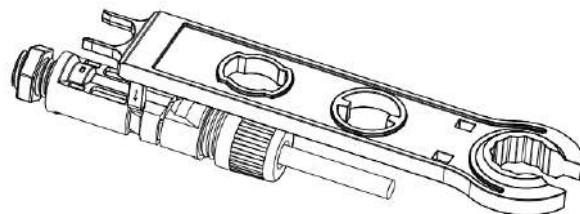
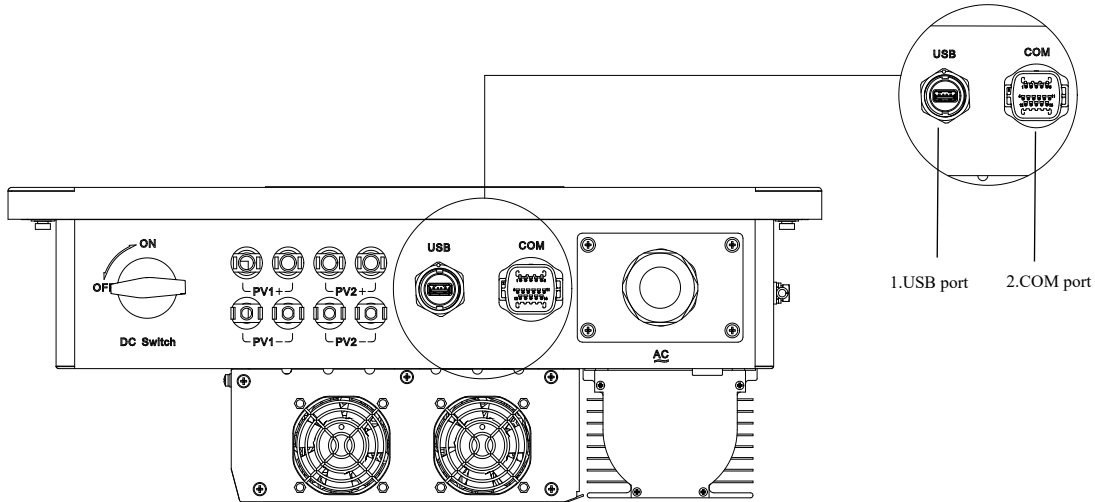

Figure 5-10 Removal DC connector

5.6 Communication Connection

Note: When layout the wiring diagram, please separate the communication wiring and power wiring in case the signal be affected.



5.6.1 USB/WIFI Port

USB/WIFI port	USB: USB PORT	Use for updating the software
	WIFI: WIFI PORT	Use for connect Wi-Fi for data transmission
<p>①</p>	<p>②</p>	<p>③</p>

WIFI

By the USB acquisition stick (WiFi), transfer the inverter power output information, alarm information, operation state to the PC terminal or local data acquisition device, then uploaded to the server. Register remote monitoring of SOFAR 15-30KTLX-G3P at its relevant website or APP according to monitoring device SN.

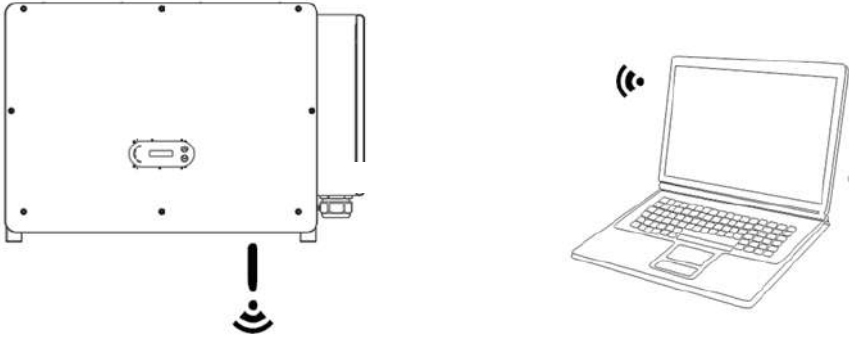

Figure 5-11 Connect one USB acquisition stick (WiFi version) to wireless router

5.6.2 COM—Multi function communication port

Table 5-3 Recommend com cable size

Name	Type	Outer diameter(mm)	Area(mm ²)
RS485 Communication Wire	Outdoor shielded twisted pair meets local standards	3core: 4~8	0.25~1

Port Description:

PIN	Define	Function	Note
1	RS485A	RS485 signal+	Wire connection monitoring or multiple inverter monitoring
2	RS485A	RS485 signal+	
3	RS485B	RS485 signal-	
4	RS485B	RS485 signal-	
5	Electric meter RS485A	Electric meter RS485 signal+	Wire connection Electric meter
6	Electric meter RS485B	Electric meter RS485 signal-	
7	GND.S	Communication ground	As RS485 signal ground or DRMS port ground
8	DRM0	Remote shunt down	DRMS port
9	DRM1/5	DRMS port logical IO	
10	DRM2/6		
11	DRM3/7		
12	DRM4/8		
13-16	Blank PIN	N/A	N/A

Procedure:

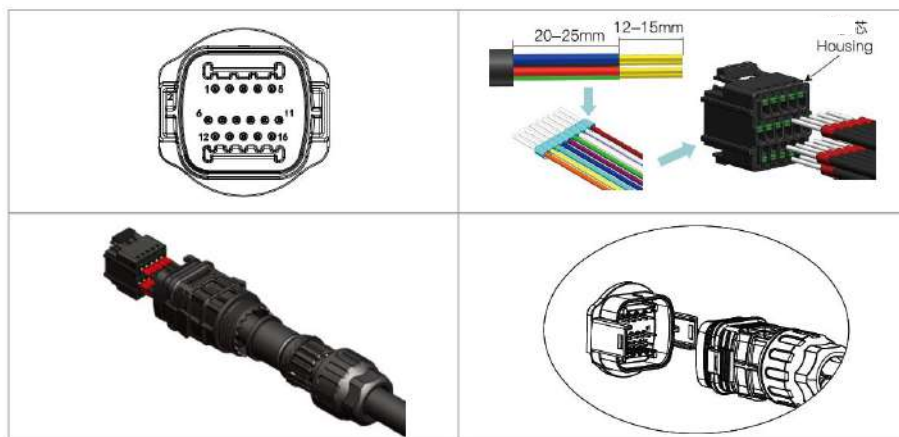

Communications Port Description

Logic interface

A. Logic interface for AS/NZS 4777.2:2020, also known as inverter demand response modes (DRMs).

The inverter will detect and initiate a response to all supported demand response commands within 2 s. The inverter will continue to respond while the mode remains asserted.

Table 5-4 Function description of the DRMs terminal

PIN	Function
9	DRM1/5
10	DRM2/6
11	DRM3/7
12	DRM4/8
7	GND.S
8	DRM0

NOTE: Supported DRM command: DRM0, DRM5, DRM6, DRM7, DRM8.

Logic interface for AS/NZS 4777.2:2020, also known as inverter demand response modes (DRMs).

The inverter will detect and initiate a response to all supported demand response commands within 2 s. The inverter will continue to respond while the mode remains asserted.

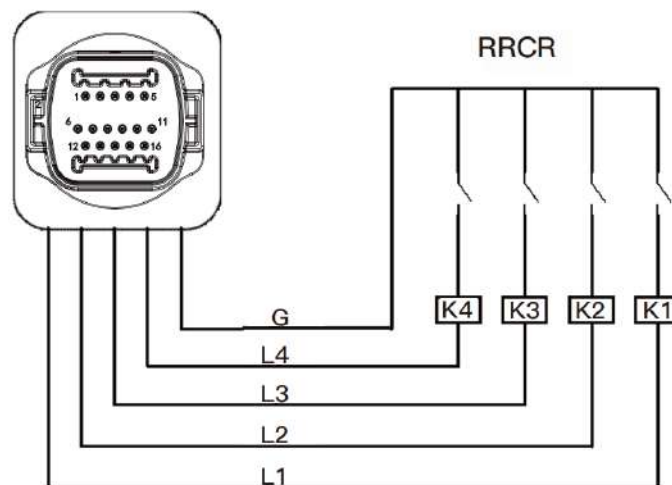

Figure 5-12 Inverter – RRCR Connection

Table 5-5 Function description of the terminal

PIN	Pin name	Description	Connected to (RRCR)
9	L1	Relay contact 1 input	K1 - Relay 1 output
10	L2	Relay contact 2 input	K2 - Relay 2 output
11	L3	Relay contact 3 input	K3 - Relay 3 output
12	L4	Relay contact 4 input	K4 - Relay 4 output
7	G	GND	Relays common node

Table 5-6 The inverter is preconfigured to the following RRCR power levels

Relay status: close is 1, open is 0

L1	L2	L3	L4	Active Power	cos(φ)
1	1 or 0	1 or 0	1 or 0	0%	1

0	1	1 or 0	1 or 0	30%	1
0	0	1	1 or 0	60%	1
0	0	0	1	100%	1

C. Logic interface for EN50549-1:2019, is in order to cease active power output within five seconds following an instruction being received at the input interface.

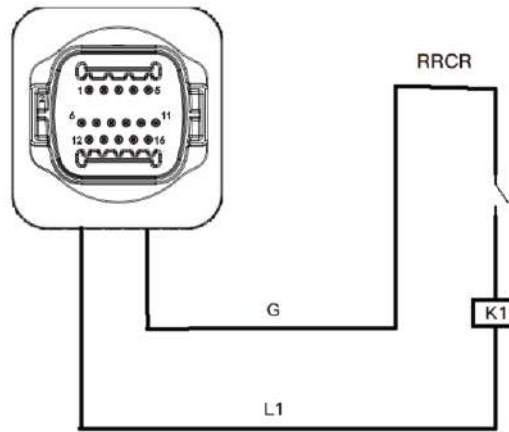

Figure 5-13 Inverter – RRCR Connection

Table 5-7 Function description of the terminal

PIN	Pin name	Description	Connected to (RRCR)
8	L1	Relay contact 1 input	K1 - Relay 1 output
7	G	GND	K1 - Relay 1 output

Table 5-8 The inverter is preconfigured to the following RRCR power levels.

Relay status: close is 1, open is 0

L1	Active Power	Power drop rate	cos(φ)
1	0%	<5 seconds	1
0	100%	/	1

RS485

By RS485 interface, transfer the inverter power output information, alarm information, operation state to the PC terminal or local data acquisition device, then uploaded to the server.

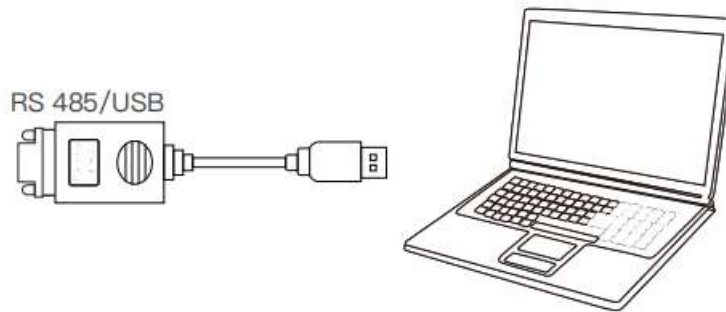

Figure 5-14 Picture of the RS485/USB converter and PC terminal

If only one SOFAR 15-30KTLX-G3P is used, use a communication cable, refer to section 7.2 for COM pin definition, and choose either of the two RS485 ports.

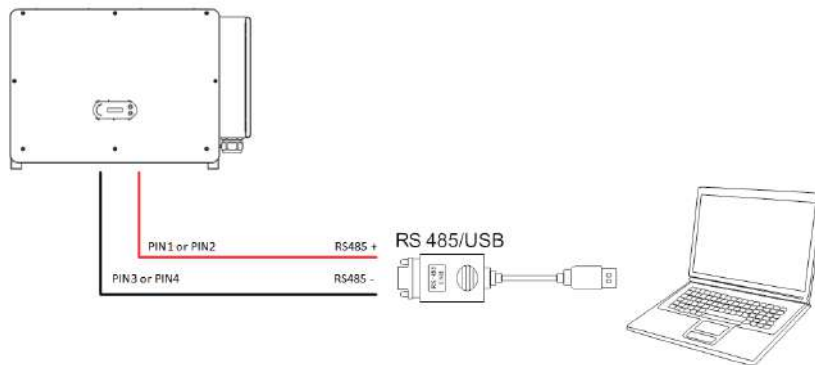

Figure 5-15 One single SOFAR 15-30KTLX-G3P connecting communications



The length of the RS485 communication cable should be less than 1000 m. The length of the WiFi communication cable should be less than 100m.

5.7 Feed-in limitation connecting line

With this function, one single inverter can dynamically limit its output power to keep the feed-in power at the point of common coupling (PCC) below a defined setpoint.

To use the feed-in limitation function, an external SmartMeter has to be connected to measure the power flow at the PCC:

The arrow of the CT's must point to the grid.

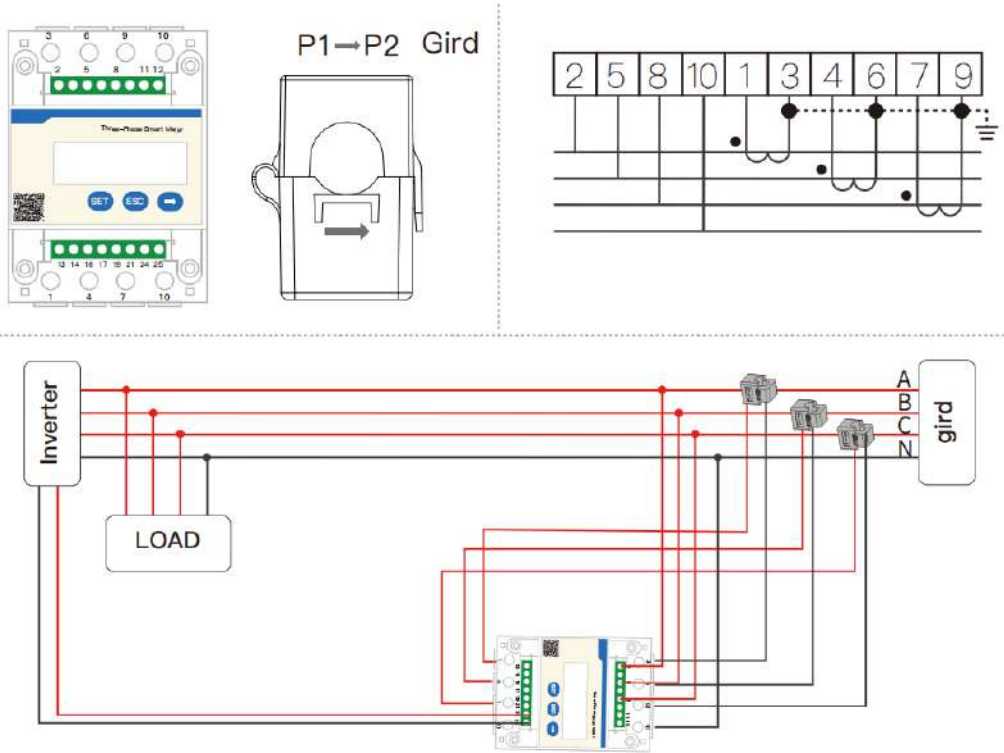

6 Commissioning of Inverter

Outlines this Chapter

Introduce SOFAR 15-30KTLX-G3P safety inspection and start processing

6.1 Cable Connection Inspection



For first time operation, check the AC voltage and DC voltage are within the acceptable range

AC grid connection

Use multimeter to confirm that three lines and PE line are connect correctly.

DC PV connection.

Use multimeter to confirm that positive pole and negative pole of PV strings, and the Voc of each string is lower than the inverter max DC input.

6.2 Start Inverter

Step 1: Turn ON the DC switch.

Step 2: Turn ON the AC circuit breaker.

Step 3:Setting the PV input mode, when parallel connection exists in the MPPT, or when a PV busbar is used, the parallel connection mode needs to be set via the LCD.

When the DC power generated by the solar array is enough, the SOFAR 15-30KTLX-G3P inverter will start automatically. Screen showing“normal”indicates correct operation.

NOTE 1: Choose the correct country safety code.

NOTE 2: Different distribution network operators in different countries have different requirements regarding grid connections of PV grid connected inverters.

Therefore, it's very important to make sure that you have selected the correct country code according to requirements of local authority. Please consult qualified electrical engineer or personnel from electrical safety authorities about this.

Shenzhen SOFARSOLAR Co., Ltd. is not responsible for any consequences arising out of incorrect country code selection.

If the inverter indicates any fault, please refer to Section 9.1 of this manual —— trouble shooting for help.

7 SOFAR monitor APP

Overview

SOFAR Monitor is a new efficient, safe and fast intelligent photovoltaic monitoring software that completes near-end debugging and remote monitoring settings. From the creation of the power station to the operation and maintenance and management to achieve integrated services, it is easy to grasp the power station information. In the power station information, not only can the monitored data information be displayed through digital and dynamic flow diagrams, but also real-time alarm notification of faults, bringing a simpler and more convenient management experience.

7.1 Software Downloads

(1) Download and install through the App Market.

Android mobile phone users: Search for "SOFAR Monitor" in the Android application market (Pea Pod, Baidu, etc.).

iPhone users search for "SOFAR Monitor" in the APP Store to download and install.

(2) You can also download "SOFAR Monitor" by scanning the QR code below.



SOFAR Monitor download

7.2 Account registration and login

7.2.1 Registered

If you do not have an account with SOFAR Monitor, please click {Register Account} at the bottom of the login screen to register.

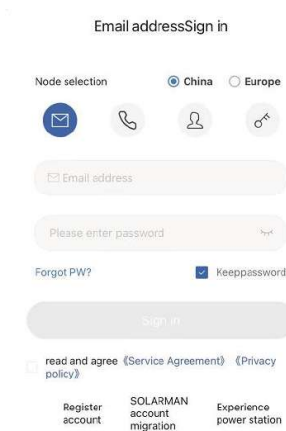

On the "Account Type" screen, click "I am a merchant", and then follow the prompts to complete the user account registration.

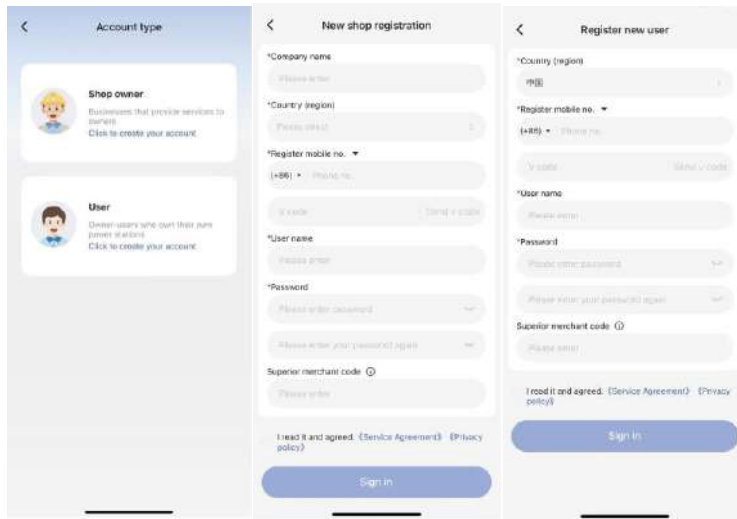

At present, mobile phone number or email account is supported for account registration; Please follow the prompts to correctly enter your mobile phone number or email account, set a login password and verify it;

After successful verification, please check the box in the agreement column to indicate that you have agreed to the Service Agreement and Privacy Agreement;

Note!For account security reasons, passwords should be 8-25 digits plus letters, no spaces, and no username. After you fill in the information correctly, click the "Register Now" button to automatically log in to the account.

7.2.2 login

If you already have a SOFAR Monitor account, log in directly on the login page. You can log in by mobile phone number, email address, and username. After logging in successfully, go to the homepage of Shouhang Monitor.

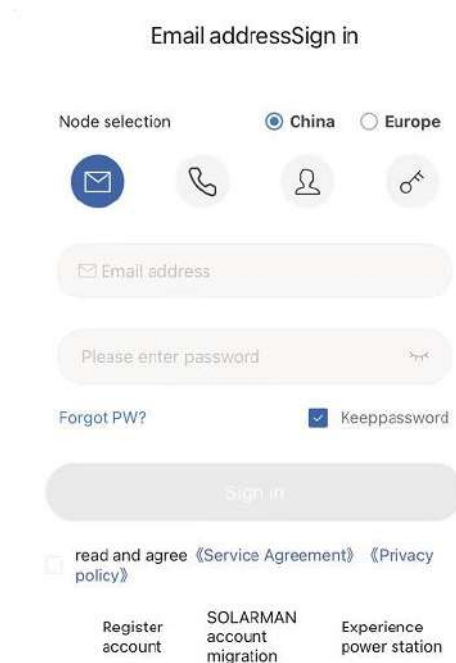

7.3 Local Monitoring

Please turn on your phone's Bluetooth in advance before using this function.

7.3.1 Bluetooth connection

Selection of connection method

Step 1: Entering the application interface, enter the sidebar, and click [Local Control], in the page, you can connect the mobile phone and the inverter through Bluetooth communication to realize near-field operation and maintenance, debugging, upgrade and safety import and other functions.

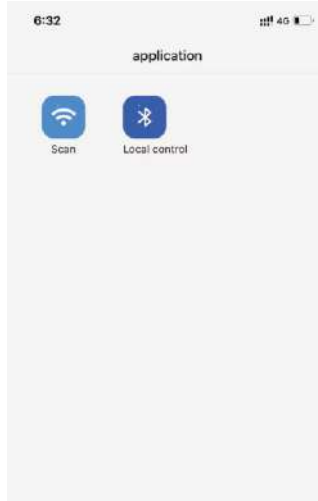

Step 2: Enter the "Connect Bluetooth" interface, there are two ways to connect, namely scan and search.

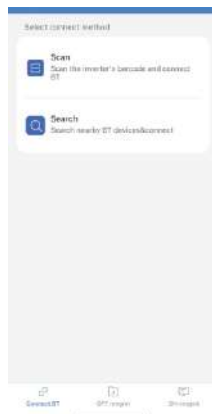

(1) Sweep: Click [Scan] will prompt you to turn on the camera on the phone, scan the SN number barcode on the inverter to start searching for the Bluetooth of the machine, and automatically connect and enter the home page after searching for the Bluetooth.



(2) Search: After clicking [Search], it will jump to the list of Bluetooth devices and start searching for nearby available Bluetooth devices, and select the device that needs to be connected according to the serial number of the

inverter.



After successfully connecting the device, enter the Bluetooth homepage.



7.4 APP operation manual

For APP function introduction and specific operation, please click [☰] in the upper left corner of the page, enter the sidebar, and click [Personal Settings]>> [About Software] >> [Operation Manual] to view detailed operation information.

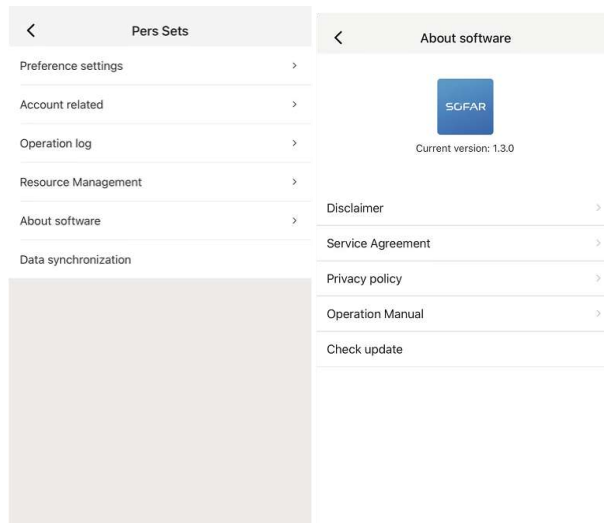

8 Operation Interface

Outlines of this chapter

This section introduces the display, operation, buttons and LED indicator lights of SOFAR 15-30KTLX-G3P Inverter.

8.1 Operation and Display Panel

Buttons and Indicator lights

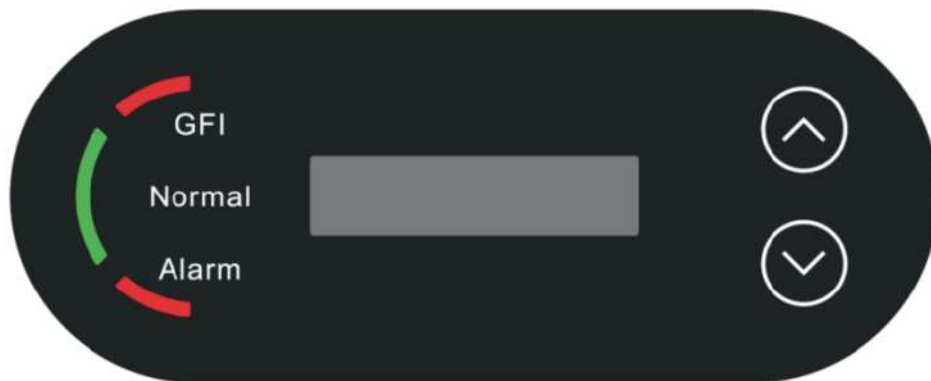

Button:

“^” Short press UP button = go up; “^” Long press UP button = exit current interface;

“v” Short press DOWN button = go down; “v” Long press DOWN button = enter current interface

Indicator Lights:

“GFI” Red light ON = GFCI faulty; “Normal” Green light flashing = counting down or checking

“Normal” Green light ON = Normal; “Alarm” Red light ON = recoverable or unrecoverable fault

8.2 Standard Interface

LCD interface indicated inverter status, alarm information, communication connection, PV input current and voltage, grid voltage, current and frequency, today generation, total generation.

Inverter working status, PV 1 -12 PV input voltage and current

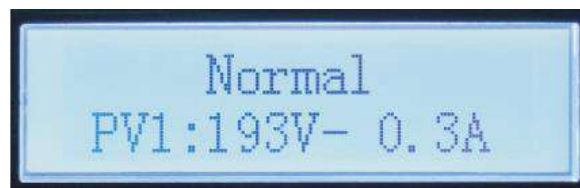

Inverter working status, PV generated power

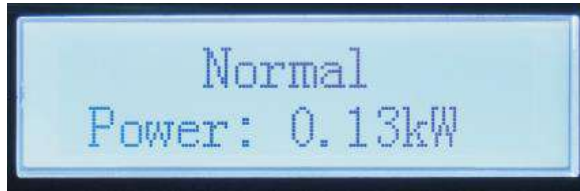

Inverter working status, today generated electricity

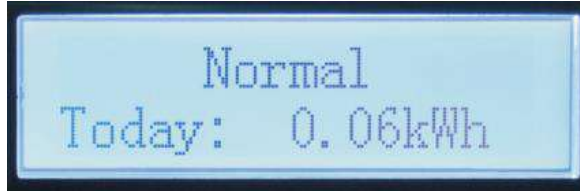

Inverter working status, total generated electricity

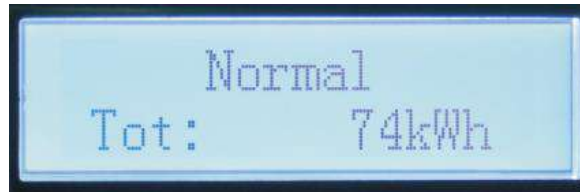

Inverter working status, grid voltage and current

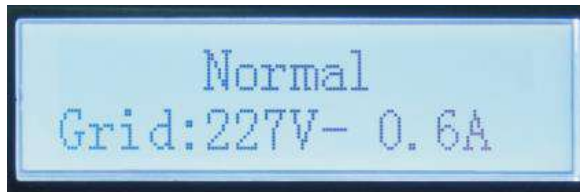

Inverter working status, grid voltage and frequency



Inverter working status, Wi-Fi/ RS485 status



Inverter faulty alarm

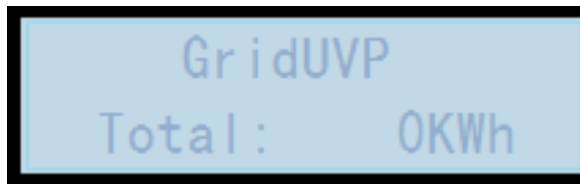

When power turn on, LCD interface displays INITIALIZING, refer below picture.



When control board successfully connected with communication board, the LCD display the current state of the inverter, display as shown in the figure below.

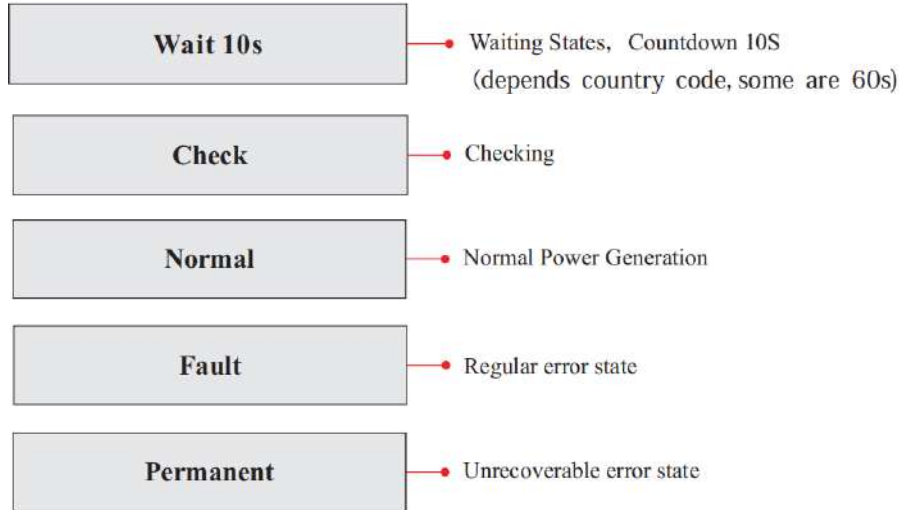

Inverter states includes: wait, check, normal, fault and permanent

Wait: Inverter is waiting to Check State when reconnect the system. In this state, grid voltage value is between the max and min limits and so on; If not, Inverter will go to Fault State or Permanent State.

Check: Inverter is checking isolation resistor, relays, and other safety requirements. It also does self-test to ensure inverter software and hardware are well functional. Inverter will go to Fault State or Permanent State if any error or fault occurs.

Normal: Inverter enter to Normal State, it is feeding power to the grid; inverter will go to Fault State or Permanent state if any error or fault occurs.

Fault: Fault State: Inverter has encountered recoverable error. It should recover if the errors disappear. If Fault State continues; please check the inverter according error code.

Permanent: Inverter has encountered unrecoverable error, we need maintainer debug this kind of error according to error code.

When the control board and communication board connection fails, the LCD display interface as shown in the figure below.



8.3 Main Interface

Long press the down button under standard interface to enter into main interface, Main interface including below information:

Normal	Long press DOWN button
	1.Enter Setting
	2.Event List

	3.SystemInfo
	4.System Time
	5.SoftwareUpdate

A. Enter setting Interface as below:

Enter Setting	Long press DOWN button	
	1.Set Time	13.PCC Select
	2.Clear Energy	14.Reflux Mode
	3.Clear Events	15.OVP
	4.Set SaftCode	16.Power Limit
	5.Remote Control	17.ReactivePara
	6.Set Energy	18.Hard Reflux
	7.Set ComProtocol	19.SetInsulation
	8.Set Inputmode	20.PELineControl
	9.Set Language	21.InputSafety
	10.Set Feed-in Limit	22.SetSafety
	11.LogicInterfac	23.AutoTest Fast
	12.IV Curve Scan	24.AutoTes STD

Long press the button to Enter the main interface of "1. Enter Setting" and long press to enter the setting menu. You can select the content you want to set by short pressing the button.

Note1: Some settings need to enter the password (the default password is 0001), when entering the password, short press to change the number, long press to confirm the current number, and long press after entering the correct password. If "password error, try again" appears, you will need to re-enter the correct password.

1. Set Time

Set the system time for the inverter.

2. Clear Energy

Clean the inverter of the total power generation.

3. Clear Events

Clean up the historical events recorded in the inverter.

4. Set SaftCode

Long press button, enter interface, save the specific file into USB and insert USB into inverter communication port.

Table 7-1 Country code setting

code	country	code	country	code	country
00	Germany VDE AR-N4105	20	Korea	40	Thailand PEA
01	CEIO-21 Internal	21	Sweden	41	Thailand MEA
02	Australia	22	Europe General	42	LV-Range-50HZ
03	Spain RD 1699	23	CEIO-21 External	43	EU EN50549
04	Turkey	24	Cyprus	44	South Africa
05	Denmark	25	India	45	AU-WA
06	Greece Continent	26	Philippines	46	Dubai DEWG
07	Netherland	27	New Zealand	47	Dubai DEWG MV

08	Belgium	28	Brazil	48	Taiwan Province, China
09	UK-G59	29	Slovakia VSD	49	AU-VIC
10	China	30	Slovakia SSE	100	AU-SA
11	France	31	Slovakia ZSD	101	AU-QLD
12	Poland	32	CEI0-21 In Areti	102	AU-VAR
13	Germany BDEW	33	Ukraine	103	AUSGRID
14	Germany VDE 0126	34	Brazil	104	Horizon
15	Italy CE10-16	35	Mexico		
16	UK.G83	36	FAR Arrete23		
17	Greece island	37	Denmark Tr322		
18	EU EN50438	38	Wide-Range-60 HZ		
19	IEC EN61727	39	Ireland		

5. Remote Control

Inverter on-off local control.

6. Set Energy

Set the total power generation. You can modify the total power generation through this option.

7. Set ComProtocol

Set the communication protocol. You can select Modbus or Sunspec from this option. If you need to monitor multiple machines at the same time, set multiple addresses. The default Modbus protocol is used and the address is 01.

8. Set Inputmode

SOFAR 15~24KTLX-G3 has 2 MPPT circuit, each MPPT circuit can work interdependently, or divided into parallel mode. User can change the setting according to the configuration.

9. Set Language

Set the inverter display language.

10. Set Feed-in Limit

Enable or disable Reflux. It is use for inverter generation and output limit control functions, but requires the use of external measuring equipment to obtain grid information.

11. Logicinterfac

Enable or disable logical interfaces. It is use for below standard Australia (AS4777), Europe General (50549), German (4105).

12. IV Curve Scan

Shadow scanning, when the component is blocked or abnormal, causing multiple power peaks, by enabling this function, the peak point of maximum power can be tracked.

13. PCC Select

The function is divided into two options: PCC Meter and PCC ARPC, the first one is the default usage for SOFAR 15-24KTLX-G3. Refer to <7.5 Smart meter instruction in this manual for specific operation methods.

14. Reflux Mode

The function is divided into three options: CTR Totalpower, CTR Phasepower and CTR SellingPower, the first one is the default usage for SOFAR 15-24KTLX-G3. Refer to <7.5 Smart meter usage in this manual for specific operation methods.

15. OVP

Set the over voltage protection value. The factory default of this value is to meet the local safety requirements.

If you need to reset it, you must strictly comply with the local safety requirements.

16. Power Limit

Set the Power Limit percent value.

17. ReactivePara

Set the Reactive Para enable/disable.

18. Hard Reflux

Set the Hard Reflux enable/disable. After hard countercurrent prevention is enabled, set the hard countercurrent power percentage.

19. SetInsulation

Set the Insulation enable/disable. Set the insulation impedance after the function is enabled.

20. PELineControl

Set the PE Line Control enable/disable.

21. InputSafety

Long press the key to enter the current menu, put the required safety files into the U disk specified folder, insert the U disk, select Enable import safety files.

22. SetSafety

Long press the key to enter the current menu, if no safety files is imported, "none" will be displayed. It is necessary to import the safety files first. After importing the safety files, you can switch safety standards according to the operation prompts.

23. Autotest Fast

18.Autotest Fast	O	Start Autotest	Long press the“√” to start
	K	Testing 59.S1...	
		↓	Wait
		Test 59.S1 OK!	
		↓	Wait
		Testing 59.S2...	
		↓	Wait
		Test 59.S2 OK!	
		↓	Wait
		Testing 27.S1...	
		↓	Wait
		Test 27.S1 OK!	
		↓	Wait
		Testing 27.S2...	
		↓	Wait
		Test 27.S2 OK!	
	↓	Wait	
	Testing 81>S1...		
	↓	Wait	

Test 81>S1 OK!		
↓	Wait	
Testing 81>S2...		
↓	Wait	
Test 81>S2 OK!		
↓	Wait	
Testing 81<S1...		
↓	Wait	
Test 81<S1 OK!		
↓	Wait	
Testing 81<S2...		
↓	Wait	
Test 81<S2 OK!		
↓	Long	press
	the“√”	
Auto Test OK!		
↓	Short	press
	the“√”	
59.S1 threshold 253V 900ms		
↓	Short	press
	the“√”	
59.S1: 228V 902ms		
↓	Short	press
	the“√”	
59.S2 threshold 264.5V 200ms		
↓	Short	press
	the“√”	
59.S2: 229V 204ms		
↓	Short	press
	the“√”	
27.S1 threshold 195.5V 1500ms		
↓	Short	press
	the“√”	
27.S1: 228V 1508ms		
↓	Short	press

	the“√”
27.S2 threshold 34.5V 200ms	
↓	Short press the“√”
27.S2: 227V 205ms	
↓	Short press the“√”
81>.S1 threshold 50.5Hz 100ms	
↓	Short press the“√”
81>.S1 49.9Hz 103ms	
↓	Short press the“√”
81>.S2 threshold 51.5Hz 100ms	
↓	Short press the“√”
81>.S2 49.9Hz 107ms	
↓	Short press the“√”
81<.S1 threshold 49.5Hz 100ms	
↓	Short press the“√”
81<.S1 50.0Hz 105ms	
↓	Short press the“√”
81<.S2 threshold 47.5Hz 100ms	
↓	Short press the“√”
81<.S2 50.1Hz 107ms	

24. Autotest STD

19.Autotest STD Long press the “√”

The test procedure is same as Autotest Fast, but it’s much more time consuming.

B. Event List:

Event List is used to display the real-time event records, including the total number of events and each specific ID No. and happening time. User can enter Event List interface through main interface to check details of real-time event records, Event will be listed by the happening time, and recent events will be listed in the front. Please refer to below picture. Long press the button and short press the button to turn the page in standard interface, then enter into “2.Event List” interface.

Event List	
1. Current Events	2. History Events
Fault information	001 ID04 06150825 (Display the event sequence number, event ID number, and event occurrence time)

C. “SystemInfo” Interface as below

SystemInfo	Long press DOWN button	
	1.Inverter Type	14.DRMs0
	2.Serial Number	15.DRMn
	3.GeneralSoftVer	16.MPPT Scan
	4.GeneralHardVer	17.ForceControl
	5.ProtocolVer	18.PCC Select
	6.Safety	19.PV-ISO
	7.SafetySwVer	20.GFCI
	8.SafetyHardVer	21.PV Strings
	9.Modbus Address	22.Reactive Power
	10.Input mode	23.Power Ratio
	11.Remote State	24.Safety Paras
	12.Reflux Enable	25.Comprotoco
	13.Reflux Power	

The user enters the main menu by long pressing the DOWN button, short press and turns the page to select menu contents, then long press the button to enter "3. SystemInfo". Turning the page down can select the system information to view.

D. Display Time

Long press the button and short press the button to turn the page in the standard user interface to enter into “4.Display Time”, then long press the button to display the current system time.

E. Software Update

User can update software by USB flash drive , SOFARSOLAR will provide the new update software called firmware for user if it is necessary. The user needs to copy the upgrade file to the USB flash drive.

8.4 Updating Inverter Software

SOFAR 15-30KTLX-G3P inverter offer software upgrade via USB flash drive to maximize inverter performance and avoid inverter operation error caused by software bugs.

Step 1: Turn off AC circuit breaker and DC switch, remove the communication board cover as below figure. If the RS485 line has been connected, please release the waterproof nut first and make sure the communication line is no longer the force. Then remove the waterproof cover.

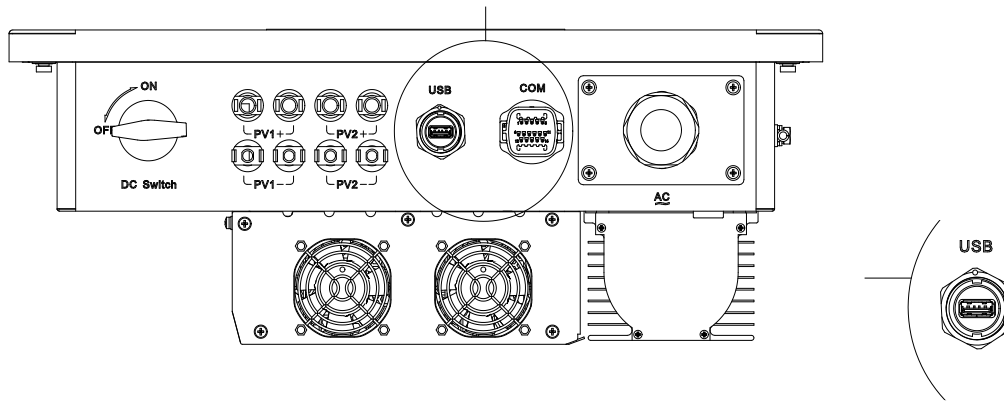

Figure 8-1 Remove communication board cover

Step 2: Insert USB into computer;

Step 3: SOFARSOLAR service team will send the software code to user, After user receive the file, please decompressing file and cover the original file in USB flash drive.

Step 4: Insert USB drive into the USB port of inverter;

Step 5: Then turn on DC switch and enter into the online upgrade to the main menu "5.Software Update" in the LCD display program[6.3(E)].The method to enter the menu can refer to operation interface of LCD.

Step 6: Input the password, if password is correct, and then begin the update process, the original password is 0715.

Step 7: System update main DSP, slave DSP and ARM in turns. If main DSP update success, the LCD will display "Update DSP1 Success", otherwise display "Update DSP1 Fail"; If slave DSP update success, the LCD will display "Update DSP2 Success", otherwise display "UpdateDSP2 Fail".

Step 8: If Fail, please turn off the DC switch, wait for the LCD screen turn off, then turn on the DC switch again, then Continue to update from step 5.

Step 9: After the update is completed, turn off the DC breaker, wait for the LCD screen extinguish, then recover the communication waterproof and then turn on the DC breaker and AC breaker again, the inverter will enters the running state. User can check the current software version in SystemInfo>>3.SoftVersion.

9 Trouble Shooting and Maintenance

9.1 Troubleshooting

This section describes the potential errors for this product. Please read carefully for the following tips when doing the troubleshooting:

1) Check the warning message or faulty codes on the inverter information panel

2) If not any error code display on the panel, please check the following lists:

- Is inverter be installed in a clean, dry, ventilated environment?
- Is the DC switch turn off?
- Are the cable cross section area and length meet the requirement?
- Are the input and output connection and wiring in good condition?
- Are the configuration settings correctly for the particular installation?

This section contains the potential errors, resolution steps, and provide users with troubleshooting methods and tips

The process to check the event list can refer to Manual Chapter 7.3 (B)

Table 8-1 Even list

Code	Name	Description	Solution
ID001	GridOVP	The grid voltage is too high	If the alarm occurs occasionally, the possible cause is that the electric grid is abnormal occasionally. Inverter will automatically return to normal operating status when the electric grid's back to normal. If the alarm occurs frequently, check whether the grid voltage/frequency is within the acceptable range. If yes, please check the AC circuit breaker and AC wiring of the inverter. If the grid voltage/frequency is NOT within the acceptable range and AC wiring is correct, but the alarm occurs repeatedly, contact technical support to change the grid over-voltage, under-voltage, over-frequency, under-frequency protection points after obtaining approval from the local electrical grid operator.
ID002	GridUVP	The grid voltage is too low	
ID003	GridOFP	The grid frequency is too high	
ID004	GridUFP	The grid frequency is too low	
ID005	GFCI	Charge Leakage Fault	Check for inverter and wiring.
ID006	OVRT	OVRT function is faulty	If the alarm occurs occasionally, the possible cause is that the electric grid is abnormal occasionally. Inverter will automatically return to normal operating status when the electric grid's back to normal. If the alarm occurs frequently, check whether the grid voltage/frequency is within the acceptable range. If yes, please check the AC circuit breaker and AC wiring of the inverter. If the grid voltage/frequency is NOT within the acceptable range and AC wiring is correct, but the alarm occurs repeatedly, contact technical support to change the grid over-voltage, under-voltage, over-frequency, under-frequency protection points after obtaining approval from the local electrical grid operator.
ID007	LVRT	LVRT function is faulty	
ID008	IslandFault	Island protection error	
ID009	GridOVPIstant1	Transient overvoltage of grid voltage 1	
ID010	GridOVPIstant2	Transient overvoltage of grid voltage 2	If the alarm occurs frequently, check whether the grid voltage/frequency is within the acceptable range. If yes, please check the AC circuit breaker and AC wiring of the inverter. If the grid voltage/frequency is NOT within the

			acceptable range and AC wiring is correct, but the alarm occurs repeatedly, contact technical support to change the grid over-voltage, under-voltage, over-frequency,
ID011	VGridLineFault	Power grid line voltage error	under-frequency protection points after obtaining approval from the local electrical grid operator.
ID012	InvVoltFault	Inverter voltage error	Internal faults of inverter, switch OFF inverter, wait for 5 minutes, then switch ON inverter. Check whether the problem is solved. If no, please contact technical support.
ID013	RefluxFault	Anti-countercurrent overload	
ID014	VGridUnbalance	grid voltage imbalance	
ID017	HwADerrIGrid	Power grid current sampling error	
ID018	HwADerrDCI(AC)	Wrong sampling of dc component of grid current	
ID019	HwADerrVGrid(DC)	Power grid voltage sampling error (DC)	
ID020	HwADerrVGrid(AC)	Power grid voltage sampling error (AC)	
ID021	HwGFCIFault(DC)	Leakage current sampling error(DC)	
ID022	HwGFCIFault(AC)	Leakage current sampling error(AC)	
ID024	HwADerrIdc	Dc input current sampling error	
ID025	HwADerrDCI(DC)	\	
ID026	HwADerrIdcBranch	\	
ID029	ConsistentGFCI	Leakage current consistency error	
ID030	ConsistentVgrid	Grid voltage consistency error	
ID031	ConsistentDCI	DCI consistency error	
ID033	SpiCommFault(DC)	SPI communication error (DC)	
ID034	SpiCommFault(AC)	SPI communication error (AC)	
ID035	SChip_Fault	Chip error (DC)	
ID036	MChip_Fault	Chip error (AC)	
ID037	HwAuxPowerFault	Auxiliary power error	
ID038	InvSoftStartFail	Inverter soft startup failed	
ID039	ArcShutdownAlarm	Arc shutdown protection	Check whether the photovoltaic module connection line and terminals have bad arc contact. If there is a fault, please repair the fault in time.
ID041	RelayFail	Relay detection failure	Internal faults of inverter, switch OFF inverter, wait for 5 minutes, then switch ON inverter.

			Check whether the problem is solved. If no, please contact technical support.
ID042	IsoFault	Low insulation impedance	Check the insulation resistance between the photovoltaic array and ground (ground), if there is a short circuit, the fault should be repaired in time.
ID043	PEConnectFault	Ground fault	Check ac output PE wire for grounding.
ID044	PvConfigError	Error setting input mode	Check the input mode (parallel/ independent mode) Settings for the inverter. If not, change the input mode
ID046	ReversalConnect	PV input polarity reverse connection error	Connect the PV assembly according to the correct polarity.
ID050	TempErrHeatSink1	Radiator 1 temperature protection	For Inner BMS battery, make sure that the battery NTC cable is properly connected. Make sure the inverter is installed where there is no direct sunlight. Please ensure that the inverter is installed in a cool/well ventilated place. Ensure the inverter is installed vertically and the ambient temperature is below the inverter temperature limit.
ID051	TempErrHeatSink2	Radiator 2 temperature protection	
ID052	TTempErrHeatSink3	Radiator 3 temperature protection	
ID053	TempErrHeatSink4	Radiator 4 temperature protection	
ID054	TempErrHeatSink5	Radiator 5 temperature protection	
ID055	TempErrHeatSink6	Radiator 6 temperature protection	
ID057	TempErrEnv1	Ambient temperature 1 protection	
ID058	TempErrEnv2	Ambient temperature 2 protection	
ID059	TempErrInv1	Module 1 temperature protection	
ID060	TempErrInv2	Module 2 temperature protection	
ID061	TempErrInv3	Module 3 temperature protection	
ID062	TempDiffErrInv	Inverter Module Temperature Difference is too large	
ID065	BusRmsUnbalance	Unbalanced bus voltage RMS	Internal faults of inverter, switch OFF inverter, wait for 5 minutes, then switch ON inverter. Check whether the problem is solved. If no, please contact technical support.
ID066	BusInstUnbalance	The transient value of bus voltage is unbalanced	
ID067	BusUVP	Busbar undervoltage during grid-connection	
ID068	BusZVP	Bus voltage low	
ID069	PVOVP	PV over-voltage	Check whether the PV series voltage (Voc) is higher than the maximum input voltage of the inverter. If so, adjust the number of PV modules in series and reduce the PV series voltage to fit the

			input voltage range of the inverter. After correction, the inverter will automatically return to its normal state.	
ID071	LLCBusOVP	LLC BUS overvoltage protection	Internal faults of inverter, switch OFF inverter, wait for 5 minutes, then switch ON inverter. Check whether the problem is solved. If no, please contact technical support.	
ID072	SwBusRmsOVP	Inverter bus voltage RMS software overvoltage		
ID073	SwBusIOVP	Inverter bus voltage instantaneous value software overvoltage		
ID082	DciOCP	Dci overcurrent protection		
ID083	SwIOCP	Output instantaneous current protection		
ID084	SwBuckBoostOCP	BuckBoost software flow		
ID085	SwAcRmsOCP	Output effective value current protection		
ID086	SwPvOCPInstant	PV overcurrent software protection		
ID087	IpvUnbalance	PV flows in uneven parallel		
ID088	IacUnbalance	Unbalanced output current		
ID089	SwPvOCP	PV overcurrent software protection		
ID090	IbalanceOCP	Inverter bus balance current protection		
ID091	SwAcCBCFault	Software AC Over Current Protection		
ID098	HwBusOVP	Inverter bus hardware overvoltage		
ID099	HwBuckBoostOCP	BuckBoosthardware overflows		
ID102	HwPVOCP	PV hardware overflows		
ID103	HwACOCP	Ac output hardware overflows		
ID104	HwDiffOCP	Hardware differential over-current		
ID105	MeterCommFault	Meters communication fault		Check whether the meters wiring is correct.
ID113	OverTempDerating	Internal temperature is too high		Make sure the inverter is installed where there is no direct sunlight. Please ensure that the inverter is installed in a cool/well ventilated place. Ensure the inverter is installed vertically and the ambient temperature is below the inverter temperature limit.
ID114	FreqDerating	AC frequency is too high	Please make sure the grid frequency and voltage is within the acceptable range.	
ID115	FreqLoading	AC frequency is too low		
ID116	VoltDerating	AC voltage is too high		

ID117	VoltLoading	AC voltage is too low	
ID129	PermHwAcOCP	Output hardware overcurrent permanent failure	Internal faults of inverter, switch OFF inverter, wait for 5 minutes, then switch ON inverter. Check whether the problem is solved. If no, please contact technical support.
ID130	PermBusOVP	Permanent Bus overvoltage failure	
ID131	PermHwBusOVP	Permanent Bus hardware overvoltage failure	
ID132	PermIpvUnbalance	PV uneven flow permanent failure	
ID134	PermAcOCPInstant	Output transient overcurrent permanent failure	
ID135	PermIacUnbalance	Permanent failure of unbalanced output current	
ID137	PermInCfgError	Input mode setting error permanent failure	Check the PV input mode (parallel/independent mode) Settings for the inverter. If not, change the PV input mode.
ID138	PermDCOCPInstant	Input overcurrent permanent fault	
ID139	PermHwDCOCP	Input hardware overcurrent permanent failure	Internal faults of inverter, switch OFF inverter, wait for 5 minutes, then switch ON inverter. Check whether the problem is solved. If no, please contact technical support.
ID140	PermRelayFail	Permanent relay failure	
ID141	PermBusUnbalance	Bus voltage unbalanced permanent failure	
ID142	PermSpdFail(DC)	PV surge protection	
ID143	PermSpdFail(AC)	Grid surge protection	
ID145	USBFault	USB fault	Check the USB port of the inverter
ID146	WifiFault	WiFi fault	Check the WiFi port of the inverter
ID147	BluetoothFault	Bluetooth fault	Check the bluetooth connection of the inverter
ID148	RTCFault	RTC clock failure	Internal faults of inverter, switch OFF inverter, wait for 5 minutes, then switch ON inverter. Check whether the problem is solved. If no, please contact technical support.
ID149	CommEEPROMFault	Communication board EEPROM error	
ID150	FlashFault	Communication board FLASH error	
ID152	SafetyVerFault	The software version is inconsistent with the safety version	
ID153	SCILose(DC)	SCI communication error (DC)	
ID154	SCILose (AC)	SCI communication error (AC)	
ID155	SCILose (Fuse)	SCI communication error (Fuse)	
ID156	SoftVerError	Inconsistent software versions	Contact for technical support and software upgrades
ID161	ForceShutdown	Force shutdown	The inverter is performed a forced shutdown

ID162	RemoteShutdown	Remote shutdown	The inverter is performed with a Drms0 shutdown
ID163	Drms0Shutdown	Drms0 shutdown	The inverter is performed a remote shutdown
ID165	RemoteDerating	Remote derating	The inverter is performed for remote load reduction
ID166	LogicIfDerating	Logic interface derating	The inverter is loaded by the execution logic interface
ID167	AlarmAntiReflux	Anti reflux derating	The inverter is implemented to prevent countercurrent load drop
ID169	FanFault1	Fan 1 fault	Please check whether the fan 1 of inverter is running normally
ID170	FanFault2	Fan 2fault	Please check whether the fan 2 of inverter is running normally
ID171	FanFault3	Fan 3 fault	Please check whether the fan 3 of inverter is running normally
ID172	FanFault4	Fan 4 fault	Please check whether the fan 4 of inverter is running normally
ID173	FanFault5	Fan 5 fault	Please check whether the fan 5 of inverter is running normally
ID174	FanFault6	Fan 6 fault	Please check whether the fan 6 of inverter is running normally
ID175	FanFault7	Fan 7 fault	Please check whether the fan 7 of inverter is running normally
ID176	MeterCommLose	Meters communication fault	Check whether the meters wiring is correct
ID189	AFCICommLose	AFCI module communication is lost	
ID191	PID_Output_Fail	PID function is failed	
ID192	PLC_Com_Fail	PLC communication is lost	Check whether the meters wiring is correct

10 Maintenance

Inverters generally do not need any daily or routine maintenance. But ensure heat sink should not be blocked by dust, dirt or any other items. Before the cleaning, make sure that the DC SWITCH is turned OFF and the circuit breaker between inverter and electrical grid is turned OFF. Wait at least for 5 minutes before the Cleaning.

Inverter cleaning

Clean the inverter using an air blower and a dry, soft cloth or a soft bristle brush. Do NOT clean the inverter with water, corrosive chemicals, cleaning agents etc.

Cleaning the heat sink

In order to help guarantee correct long-term operation of the inverter, make sure that there is sufficient space for ventilation around the heat sink. Check the heat sink for blockages (dust, snow etc.) and remove them if present. Clean the heat sink using an air blower and a dry, soft cloth or a soft bristle brush. Do NOT clean the heat sink with water, corrosive chemicals, cleaning agents etc.

Fan maintenance

Fans must be cleaned and maintained regularly for both performance and safety concerns

NOTE

Defective or dirty fans can reduce the performance of the inverter. Broken or faulty fans may cause cooling issues, which may lead to limited performance. Broken or faulty fans may cause cooling issues, which may lead to limited performance. Clean fans regularly.

10.1 Replacing a Fan

Follow below steps for maintenance:

1. Before replacing a fan, power off the inverter.
2. When replacing a fan, use insulation tools and wear personal protective devices.

Step 1: Remove the screw on the fan tray and save it, Extract the fan bracket about 5-10cm.

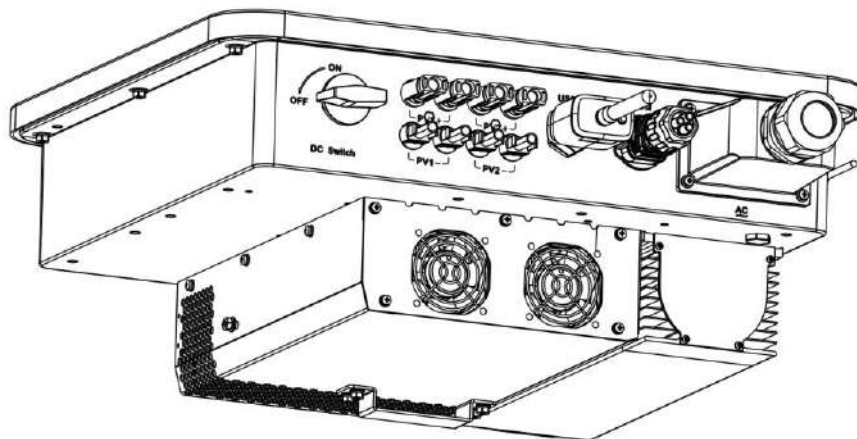

Step 2: Unscrew four screws at the corner of fans baseboard ;

Step 3: Remove the screws at the fan position, unplug the terminal at the fan and inverter interface and completely remove the fan;

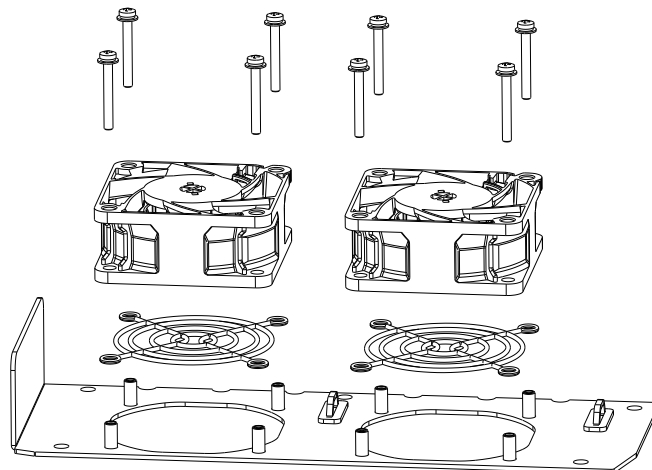

Step 4: Use a soft brush to clean the fan. If it is damaged, please replace it in time;

Step 5: Re-install the inverter according to the above steps.

11 Technical Data

Outlines of this Chapter

This topic lists the technical specifications for SOFAR 15-30KTLX-G3P inverter.

11.1 Parameter Table

	SOFAR 15KTLX- G3P	SOFAR 17KTLX- G3P	SOFAR 20KTLX- G3P	SOFAR 20KTLX2 -G3P	SOFAR 23KTLX- G3P	SOFAR 25KTLX- G3P	SOFAR 30KTLX- G3P
Input (DC)							
Max. input voltage	1100V						
Rated input voltage	620V						
Start-up voltage	180V						
MPPT operating voltage range	160V~1000V						
Number of MPP trackers	2			2			
Number for DC inputs	1/2		2/2		2/2		
Max. input MPPT current	20A/32A		40A/32A		40A/32A		40A/40A
Max. input short-circuit current	25A/40A		50A/40A		50A/40A		50A/50A
Output(AC)							
Rated output power	15000W	17000W	20000W	20000W	23000W	25000W	30000W
Max. apparent power	16500VA	18700VA	22000VA	22000VA	25300VA	27500VA	33000VA
Rated output current	22.8A/380 Vac	25.9A/380 Vac	30.4A/380 Vac	30.4A/380 Vac	35A/380V ac	38A/380V ac	45.6A/380 Vac
	21.8A/400 Vac	24.7A/400 Vac	29A/400V ac	29A/400V ac	33.4A/400 Vac	36.3A/400 Vac	43.5A/400 Vac
	20.9A/415 Vac	23.7A/415 Vac	27.9A/415 Vac	27.9A/415 Vac	32A/415V ac	34.8A/415 Vac	41.7A/415 Vac

Max. output current	25.1A	28.5A	33.5A	33.5A	38.5A	41.8A	50.2A
Rated output voltage	3/N/PE, 220Vac / 380Vac, 230Vac / 400Vac, 240Vac / 415Vac						
Output voltage range	310~480Vac						
Rated output frequency	50/60Hz						
Output frequency range	45Hz~55Hz/55Hz~65Hz						
Active power adjustable range	0~100%						
Power factor	0.8 leading – 0.8 lagging						
Efficiency							
Max. efficiency	≥98.6%						
European efficiency	≥98.1%						
General Data							
Ambient temperature range	-30°C~+60°C						
Self-consumption at night	<1W						
Topology	Transformerless						
Degree of protection	IP66						
Allowable relative humidity range	0~100%						
Max. operating altitude	4000m(>2000m derating)						
Cooling	Smart air cooling						
Dimension(W×H×D)	491 × 412 × 188 mm						

Weight	19kg	20kg	20.5kg	20.5kg	21kg
Display	LED & Bluetooth +APP				
Communication	RS485, USB, WiFi				

Version 1.0



ENERGY TO POWER YOUR LIFE

ADDRESS

11th Floor, Gaoxingqi Technology Building,
District 67, Xingdong Community, Xin'an Street,
Bao'an District, Shenzhen, China

EMAIL

info@sofarsolar.com

WEBSITE

www.sofarsolar.com

SOFARSOLAR 

